

Please read carefully prior  
to installing and servicing.

SAVE THESE INSTRUCTIONS

# Operating Manual

Pellet heating with auger  
delivery or vacuum suction  
system for the end-user

**AutoPellet®**

**PES 20, 32, 56**

MESys V1.1

AutoPellet TOUCH

USA



Title: Operating Manual AutoPellet® **PES 20, 32, 56**

Article number:

Version valid from: **02/2025**

Approved: **Maine Energy Systems**

## **Author & Manufacturer**

MAINE ENERGY SYSTEMS LLC  
8 Airport Road — P.O. Box 547 Bethel  
Maine 04217

E-Mail: [info@maineenergysystems.com](mailto:info@maineenergysystems.com)  
[www.maineenergysystems.com](http://www.maineenergysystems.com)

© MAINE ENERGY SYSTEMS LLC  
Subject to modifications

Pour la version française de ce manuel, veuillez visiter notre site Web à  
[Maineenergysystems.com](http://Maineenergysystems.com).

<b>1 Dear Customer .....</b>	<b>5</b>
<b>2 Use only for the purpose intended .....</b>	<b>6</b>
<b>3 Types of safety warning sign .....</b>	<b>7</b>
<b>4 Warnings and safety instructions.....</b>	<b>8</b>
4.1 Basic safety instructions .....	8
4.2 Warning signs.....	8
4.3 What to do in an emergency.....	10
<b>5 Prerequisites for installing a pellet boiler .....</b>	<b>11</b>
5.1 Guidelines and standards for installing a pellet boiler .....	11
5.2 Installation room.....	11
5.3 Flue gas system.....	12
5.4 Safety systems .....	15
5.5 Installation with an existing boiler.....	15
<b>6 Fuel .....</b>	<b>17</b>
6.1 Specification for high quality pellets as per EN ISO 17225-2, class A1 and by PFI standards in North America.....	17
6.2 Distance to flammable materials.....	18
6.3 Storing the pellets .....	18
6.4 Measures for the ventilation of storage rooms.....	18
<b>7 Product description .....</b>	<b>19</b>
7.1 The pellet boiler.....	19
7.2 Pellet suction system.....	22
7.3 Auger delivery system .....	22
7.4 Storage systems.....	23
7.4.1 Pellet storage room.....	23
7.4.2 Flexilo fabric tank.....	23
<b>8 Operating the Pellematic.....</b>	<b>24</b>
8.1 Operating the heating system .....	24
8.2 Description of the control panel .....	25
8.3 Setting language, date and time at Pelletronic Touch.....	25
8.4 Operating Device with Touch screen .....	28
8.5 Opening window .....	28
8.6 User controls and their function .....	29
8.7 Main Menu .....	31
<b>9 Mode .....</b>	<b>33</b>
<b>10 Measuring Values.....</b>	<b>34</b>
<b>11 Weather .....</b>	<b>35</b>
<b>12 Heating Circuit .....</b>	<b>36</b>
12.1 Measuring values Heating circuit .....	37
12.2 Time programme Heating circuit .....	38
12.3 Party .....	39
12.4 Vacation .....	39
12.5 Heating curve and Heating limits .....	40
<b>13 Domestic hot water .....</b>	<b>43</b>
13.1 Measuring values Domestic hot water.....	44
13.2 Time programme DHW .....	44
<b>14 DHW Return pump .....</b>	<b>45</b>
14.1 Measuring values DHW Return pump .....	46
14.2 Time programme DHW return pump .....	46
<b>15 Solar.....</b>	<b>47</b>
15.1 Measuring values Solar.....	47
15.2 Solar circuit.....	48
15.3 Yield - Solar Energy.....	49
<b>16 Pellematic.....</b>	<b>50</b>
16.1 Measuring values.....	50
16.2 Full Power.....	51

---

16.3	Boiler cleaning.....	52
16.4	Level detection system.....	53
16.5	Suction turbine.....	54
<b>17</b>	<b>General .....</b>	<b>55</b>
17.1	Chimney .....	56
17.2	Favorite .....	56
17.3	Local Settings.....	58
17.4	Malfunction.....	59
	17.4.1 Malfunction report .....	59
17.5	Information.....	76
17.6	ModBUS .....	77
17.7	E-Mail.....	78
17.8	IP Config.....	79
<b>18</b>	<b>Software .....</b>	<b>84</b>
<b>19</b>	<b>Emptying the ash pan .....</b>	<b>85</b>
<b>20</b>	<b>Emptying the ash box .....</b>	<b>86</b>
<b>21</b>	<b>Maintenance and servicing .....</b>	<b>88</b>
21.1	Maintenance.....	88
21.2	Cleaning the boiler every year .....	89
21.3	Maintenance intervals .....	94
21.4	Repairs .....	94
21.5	Checking the boiler room and storage room.....	94
<b>22</b>	<b>Data for 20KW model, including emissions .....</b>	<b>95</b>
<b>23</b>	<b>Data for 32KW model, including emissions .....</b>	<b>96</b>
<b>24</b>	<b>Data for 56KW model, including emissions .....</b>	<b>97</b>
<b>25</b>	<b>General information .....</b>	<b>98</b>

Note that warranty and replacement part information is included at the end of this manual. For warranty questions, refresher training, or replacement part inquiries (for all replacement parts including those pertaining to emissions control such as gaskets or other), please send an email to [info@maineenergysystems.com](mailto:info@maineenergysystems.com) including the system's address in the subject line. MESys provides replacement parts for installation by certified technicians.

# 1 Dear Customer

**Maine Energy Systems** specializes in wood pellet heating.

Our company enjoys an exclusive license from ÖkoFEN to manufacture products here in North America. We represent expertise, innovation and quality.

We are delighted that you have decided to purchase our product.

- This instruction manual is intended to help you operate the product safely, properly and economically.
- Please read this instruction manual completely and take note of the safety warnings.
- Keep all documentation supplied with this unit in a safe place for future reference.
- Installation and first startup must be carried out by a qualified installer certified by Maine Energy Systems.
- The installation must comply with the requirements of the Authority having jurisdiction over the installation.
- Please contact your authorized dealer if you have any questions.



We place great importance on the development of new products. Our R&D department continues to question accepted solutions and works continually on new improvements. That is how we maintain our technological lead. We have already received several awards for our products in Austria and abroad. Our products fulfill European and USA requirements regarding quality, efficiency and emissions.



This wood heater needs periodic inspection and repair for proper operation. It is against federal regulations to operate this wood heater in a manner inconsistent with operating instructions in this manual.

This heating appliance is US EPA 2020 NSPS Compliant.

## 2 Use only for the purpose intended

The pellet boiler is designed to heat water for central or other indirect heating systems and hot water supply for buildings. It is not permissible to use the pellet boiler for any other purpose. Reasonable foreseeable inadvertent uses for the pellet boiler are not known.

The boiler fulfills the requirements of UL 2523-18 and CSA B366.1-11 (R2020).

This boiler is intended to be fueled by Pellet Fuels Institute (PFI) Certified Wood Pellets.

### 3 Types of safety warning sign

The warning signs use the following symbols and texts.

#### Types of safety warning sign

1. Risk of injury
2. Consequences of risk
3. Avoiding risk



#### 1. Risk of injury:

Danger - indicates a situation that could lead to death or life-threatening injury.



Warning - indicates a situation that could lead life-threatening or serious injury.



Caution - indicates a situation that could lead to injury.



Note - indicates a situation that could lead to property damage.



#### 2. Consequences of risk

Effects and consequences resulting from incorrect operation.

#### 3. Avoiding risk

Observing safety instructions ensures that the heating system is operated safely

## 4 Warnings and safety instructions

Observing safety instructions ensures that the heating system is operated safely.

### 4.1 Basic safety instructions

- Never get yourself into danger; give your own safety top priority.
- Keep children away from the central heating room and storage room.
- Observe all safety warnings on the boiler and in this user manual.
- Observe all instructions relating to maintenance, servicing and cleaning.
- The pellet heating system may only be installed and commissioned by an installer that is trained and remains currently authorized by Maine Energy Systems.
- Never make any changes to the heating system or flue gas system. All maintenance, cleaning and changes should only be done by trained professionals.
- Never close or remove safety valves.

### 4.2 Warning signs



#### **DANGER**

##### **Risk of poisoning**

Make sure that the pellet boiler is supplied with sufficient combustion air.

The openings in the combustion air inlet must never be partially or completely closed.

Ventilation systems, central vacuum cleaning systems, extractor fans, air conditioning systems, flue gas blowers, dryers, fuel storage ventilation fans or similar equipment must never be allowed to draw air from the boiler room and cause a drop in pressure.

The boiler must be connected tight to the chimney using a flue gas tube.

Clean the chimney and the flue gas tube at regular intervals.

The boiler room and pellet storage room must be sufficiently supplied with air and ventilated.

Before entering the storage room it must be ventilated with sufficient air and the heating system switched off.



#### **DANGER**

##### **Risk of electric shock**

Always disconnect / de-energize the power supply before working on the boiler.



#### **DANGER**

##### **Risk of explosion**

DO NOT BURN GARBAGE, GASOLINE, NAPHTHA, ENGINE OIL, OR OTHER INAPPROPRIATE MATERIALS. DO NOT USE CHEMICALS OR FLUIDS TO START THE FIRE.

Switch off the heating system before filling the storage room.





## DANGER

### Risk of fire

Do not store any flammable materials in the boiler room.  
Do not hang out any washing in the boiler room.  
Do not operate with fuel loading or ash removal doors open.



## WARNING

### Risk of burns

Do not touch the flue gas connector or flue gas pipe.  
Do not reach into the ash chamber.  
Do not clean the boiler until it has been allowed to cool down.



## CAUTION

### HOT SURFACES

Keep children away.  
Do not touch during operation.  
Do not operate if maximum draft as listed on boiler nameplate is exceeded.  
Doing so can allow non-controlled combustion.



## CAUTION

**Risk of cut injuries due to sharp edges.**  
Use gloves for performing all work on the boiler.

## NOTICE

### Damage to property

The pellet boiler is suitable only for pellets which comply with PFI premium or EnPlus -A1 pellets specifications.  
The use of any other fuel voids your warranty and can cause damage to the pellet boiler and chimney.

## NOTICE

### Damage to property

Do not use the heating system if it, or any of its components, come into contact with water.  
If water damage occurs, check the heating system and replace damaged parts.



## WARNING

All cover plates, enclosures, and guards must be maintained in place at all times, except during maintenance and servicing.

## 4.3 What to do in an emergency



### DANGER

**Risk to life**

Never get yourself into danger; give your own safety top priority.

**What to do in the event of a fire**

- Switch off the heating system.
- Call your local fire department and / or 911.
- Use approved fire extinguishers (fire protection class ABC).

**What to do if you smell smoke**

- Switch off the heating system.
- Close the doors leading to living areas.
- Ventilate the boiler room.

**Important:** Federal, State/Provincial, and Local Regulations, Laws, and Codes must be followed; use of smoke detectors and carbon monoxide monitors are recommended in accordance with applicable statutes.

**INSTALL CO SMOKE DETECTORS IN THE LIVING AREA AND BEDROOMS OF YOUR HOME. TEST THEM REGULARLY AND INSTALL FRESH BATTERIES TWICE ANNUALLY.**

**WHEN INSTALLED IN THE SAME ROOM AS THE STOVE, A SMOKE OR CARBON MONOXIDE DETECTOR SHOULD BE LOCATED AS FAR FROM THE STOVE AS POSSIBLE TO PREVENT THE ALARM SOUNDING WHEN ADDING FUEL.**

## 5 Prerequisites for installing a pellet boiler

You must fulfill the following conditions before operating a fully automatic pellet boiler.

### 5.1 Guidelines and standards for installing a pellet boiler

Overview of standards and guidelines applying to the installation of a pellet boiler.

Check whether you need to obtain planning permission or approval from the authorities for installing a new heating system or changing your existing system. Legislation in your country must be observed.

Flue gas system	EN 13384-1	Legislation in your country must be observed.
Building and fire prevention regulations		Legislation in your country must be observed.
Type of installation	FC 42x	Fireplace with a flue gas fan for connection to an air exhaust system. The combustion air line from air shaft and the connecting piece to the chimney are part of the fireplace.
	FC 52x	Fireplace with a flue gas for connection to a chimney. The combustion air line from outside and the connecting piece to the chimney are part of the fireplace.
Sound insulation	DIN 4109	Please note the building-unique demands on sound insulation.

### 5.2 Installation room

The installation room of the boiler is not necessarily a boiler room. Observe the applicable national and regional regulations.

#### 1. Safety warnings for the installation room

DANGER

**Risk of fire**  
 Do not store flammable materials or liquids in the vicinity of the pellet boiler.  
 Do not permit unauthorized persons to enter the boiler room - Keep children away.  
 Do not operate with fuel loading or ash removal doors open.

#### 2. Ventilation of the installation room

The installation room must have air inlet and outlet openings for ventilation, even if there is a direct connection to the burner for combustion air. This is to keep the combustion zone at a neutral pressure. For each pellet boiler in the room, there must be at least 31square inches of opening to outside air, NOT to an adjacent room.

#### 3. Admission of combustion air,

**the pellet boiler requires combustion air. The combustion air can be supplied by:**

- a. Relying upon the boiler room air as supplied by the air inlet and outlet openings for ventilation in the installation room.
- b. Independently of the room air via a separate air intake line with a direct connection to the outdoor atmosphere.  
 The air intake line must not follow the sewage pipe. The diameter of the air intake line must be at least 4 inches. If the air line is greater than 12 feet in length, or if it has more than 270 degrees of turns, then it should be increased in size to 5 inch.

Never operate the pellet boiler if the air intake openings are partially or completely closed.

Contaminated combustion air can cause damage to the pellet boiler. Never store or use cleaning detergents containing chlorine, nitrobenzene or halogen in the room where the heating system is installed, if combustion air is drawn directly from the room. Be particularly cautious around swimming pools and

chemicals.

Do not hang out washing in the boiler room.

Prevent dust from collecting at the combustion air intake to the pellet boiler.

4. **System damage due to frost and humidity**

The temperature in the installation room must not drop below 38°F and must not exceed +86°F. The relative humidity in the installation room must not exceed 70%.

5. **Danger for animals**

Prevent pets and other small animals getting into the installation room. Install grilles over all openings.

6. **Flooding**

In the event of a flooding risk, switch off the pellet boiler and disconnect it from the main power supply before water enters the boiler room. All components that come into contact with water must be replaced before the pellet boiler is put into operation again.

### 5.3 Flue gas system

The flue gas system consists of a chimney and a flue gas tube. The flue gas tube connects the pellet heating system to the chimney. The chimney leads the flue gas from the pellet heating system out into the open.

1. **Design of the chimney**

The dimensions and design of the chimney is very important. The chimney must be able to ensure sufficient draft to safely draw away the flue gas regardless of the status of the boiler. Low flue gas temperatures can cause sooting and moisture damage on chimneys that are not insulated. For this reason **moisture-resistant chimneys** (stainless steel or ceramic) should be used. An existing chimney that is not damp-resistant needs to be renovated before use. Follow guidelines below:

Boiler size		AutoPellet
Flue gas tube diameter (at boiler)	inch/mm	6/160
Flue gas temp. / rated power	° F	266 - 320
Flue gas temp. / partial load	° F	194 - 248
Min. draft (full load/part load) to Max draft	in/wc	- 0.04 / - 0.02 to -0.11

Chimney size	Min. Height
6in x 6in	17ft
7in x 7in	16ft
8in x 8in	16ft
6in round	19ft
7in round	17ft

NOTICE

Person(s) operating a hydronic heater is/are responsible for operation in a manner that does not create a public or private nuisance condition. The manufacturer's distance and stack height recommendations and the requirements in any applicable laws or other requirements may not always be adequate to prevent nuisance conditions due to terrain or other factors.

Recommended and UL-103HT approved chimney materials are:

- a. Selkirk sure temp
- b. Supervent (JSC)
- c. Security chimneys (secure temp ASHT)

Use flue gas pipe from chimney to boiler as required by your local code.

	<b>CAUTION</b>
<b>Unregulated combustion</b> Please observe that combustion air openings and flue pipes are not reduced in size or closed. Make end user aware of these guidelines and their potential danger. Clean the chimney and the flue gas tube at regular intervals. Check if the draft inducer is clean and in a good condition.	

## 2. Flue gas temperature

The flue gas temperatures are approximately the same for all AutoPellet covered in this manual.

The dewpoint of flue gas with wood pellets (max. 10% water content) is approx. 120°F.

It is possible to increase the flue gas temperature to prevent condensation inside the chimney and avoid damage due to damp. Only authorised installers may increase the flue gas temperature.

### Note:

The increase in flue gas temperature results in reduced efficiency and thus increases fuel consumption.

## 3. Negative pressure of the chimney

The boiler must be connected to a chimney or a vertical venting system that is capable of handling and producing a negative breeching pressure of **-0.04** "WC. Use a draft gauge to verify the indicated draft value, adjust barometric damper as required. Drill a small hole in the connection pipe at about 2in/ 50mm from the boiler flue outlet and use this hole as your measuring point.

### Chimney draft

The suction effect of the chimney draft must extend all the way to the boiler flue pipe connection. The maximum flow rate that can be drawn through the chimney limits the maximum performance of the chimney connection. The boiler performance must be reduced if the chimney does not possess the necessary cross-section. This may only be performed by authorised personnel.

## 4. Cleaning

Clean the flue gas tube and chimney regularly. Solid fuel burning appliances need to be cleaned frequently because soot, creosote, and ash may accumulate. The hotter the fire, the less creosote is deposited. Cleaning intervals can vary in warm periods due to this and become more frequent.



## DANGER

### Risk of chimney fire

Creosote-formation and need for removal: Low flue gas temperature can cause creosote. Creosote can condense in a relatively cool chimney. As a result, creosote residue accumulates on the flue lining. If ignited, this creosote will create an extremely hot fire. The chimney and the chimney connector should be inspected at least twice monthly during the heating season to determine if a creosote buildup has occurred. If creosote has accumulated it should be removed to reduce the risk of a chimney fire.

## NOTICE

### Oxidation of chimney

Do not use metal brushes to clean chimneys made of stainless steel.  
Your state and local regulations must be observed.

## 5.4 Safety systems

The following safety measures are the prerequisite for safe operation of your system.

### Emergency stop switch

Every heating system must be able to be switched off with an Emergency Stop switch. The Emergency Stop switch location is determined by your local code requirement. It should remove all electrical power from the boiler.



### Safety valve / Over Pressure Relief Valve

This valve opens when the pressure inside the heating system increases to max. 43.5 PSI. For North America, a 30 PSI Relief Valve is supplied with each boiler. This valve must not be locked out or plugged and must be within 3 feet of the boiler, with no valves between the relief valve and boiler.



### Low Water Detection

The "Low Water Detection" device is connected to the Emergency Stop of the boiler. Should a low water condition be detected, the boiler stops firing immediately. This device must be of the manual reset variety.



### Safety temperature sensor

The pellet boiler is equipped with a safety temperature sensor. This is located on the pellet boiler. If the boiler temperature exceeds 230° F, then the heating system switches off.



### Expansion tank

All heating systems must be equipped with an expansion tank. The overall size of the heating system volume will dictate the required expansion tank size.



### Barometric Controller

All heating systems must be equipped with a barometric controller (see section 5.3.1).

## NOTICE

### Initial start-up

The initial start-up of each MESys boiler must be performed by an authorized installer.

## 5.5 Installation with an existing boiler

MESys boilers are not to be connected to a chimney flue serving another appliance. However, when all State and local codes allow for the sharing of chimney flues, MESys boilers and another appliance burning pellets or a different fuel can be operated simultaneously while connected to a single existing chimney or flue gas system providing the following conditions are met:

- All state and local codes permit the specific installation.
- All appliances are installed in accordance with the manufacturer's installation specifications or if lacking manufacturers specifications, the appliance in question is installed in a manner commonly recognized as safe and correct for the application and circumstances.
- The chimney or flue gas system must be able to handle the combustion products of either appliance and

## NOTICE

### Avoid clearance issues that can make servicing difficult:

Be sure to follow suggested clearances when installing this boiler with an existing boiler to be sure that service and cleaning can be performed adequately.



## CAUTION

**Avoid code violations:**

When connecting to or with an existing boiler, contact the authority having jurisdiction to be sure the type of installation planned is allowed.

Document the type of boiler that the Pellematic is connected to or with.

Pellet boiler: Make and Model number:

\_\_\_\_\_

Existing boiler: Make and Model number:

\_\_\_\_\_



## DANGER

**Possible escape of flue gas:**

Do not connect this unit to a chimney flue serving another appliance unless multiple appliances into a single flue is authorized by all authorities having jurisdiction.



## 6 Fuel

Wood pellets are natural wood (dried sawdust or waste from machining) that has been formed into pellets under high pressure. They have a very low moisture content and very high calorific value. The manufacture of wood pellets is regulated by European standard EN ISO 17225-2.

Fuel Property	PFI Premium
<b>Normative Information - Mandatory</b>	
Bulk Density, lb./cubic foot	40.0 - 46.0
Diameter, inches	0.230 - 0.285
Diameter mm	5.84 - 7.25
Pellet Durability Index	≥ 96.5
Fines, % (at the mill gate)	≤ 0.50
Inorganic Ash, %	≤ 1.0
Length, % greater than 1.50 inches	≤ 1.0
Moisture, %	≤ 8.0
Chloride, ppm	≤ 300
Heating Value	NA
<b>Informative Only - Not Mandatory</b>	
Ash Fusion	NA



### WARNING

Never use pellets that contain treated wood, colored paper products, cardboard, solvents, plastic trash or garbage.

Never burn trash, plastics, gasoline, solvents, naphtha, household garbage, material treated with petroleum products such as particleboard, railroad ties and pressure treated wood leaves, paper products, cardboard.

### 6.1 Specification for high quality pellets as per EN ISO 17225-2, class A1 and by PFI standards in North America

Calorific value	≥ 4,6 kWh/kg or ≥ 16,5 MJ/kg
Loose density	min. 600 kg/m <sup>3</sup>
Water content	max. 10% Specification for high quality pellets as per EN ISO 17225-2, class A1
Ash content	max. 0.7%
Length	max. 40 mm
Diameter	6 mm
Fine material	max. 1%
Contents	100% natural wood

## NOTICE

The heating system is suitable only for pellets of natural wood that comply with standard EN ISO 17225-2 class A1 with a diameter of 6 mm. Using non-pelletised fuels or pellets that are not manufactured from natural wood will lead to the warranty becoming void and will cause damage to the pellet boiler and the chimney.

Use only quality pellets that are DINplus or ENplus or PFI premium Certified.



## WARNING

Never use pellets that contain treated wood, colored paper products, cardboard, solvents, plastic, trash or garbage

Never burn trash, plastics, gasoline, solvents, naphtha, household garbage, material treated with petroleum products such as particleboard, railroad ties and pressure treated wood, leaves, paper products, cardboard.

## 6.2 Distance to flammable materials

Observe the country-specific regulations, Local Regulations or NFPA.

## 6.3 Storing the pellets

1. Pellets are to be stored in a place where they are kept dry all year.
2. Install a back-ventilated partition to prevent pellets from contacting damp walls, or use a fabric tank.
3. Refer to our planning hints for pellet storage rooms and warning signs.
4. Legislation in your country must be observed regarding building specifications for storage rooms.
5. ÖkoFEN also offers FleXILO fabric tanks for storing pellets.

## 6.4 Measures for the ventilation of storage rooms

To avoid any kind of danger through possible degassing of the pellets, make sure you obey the following guidelines:

- The storage room has to be insulated towards the living area.
- The storage room has to be ventilated to the outdoors.

For further information please consult your expert adviser.

# 7 Product description

The description of the product is intended to provide an overview of the components that make up an ÖkoFEN pellet heating system, the parts of the pellet boiler and advice on where you can find more information.

The ÖkoFEN concept features different sizes of design and type for each component. These are compatible and designed to match.

## The ÖkoFEN pellet heating system consists of 3 components

1	Pellematic pellet boiler
2	Conveyor system
3	Storage system - storage room or fabric tank

## 7.1 The pellet boiler

The pellet boiler is equipped with an automatic cleaning system, an ash box with ash compression system and an integrated return water temperature control. The installed programmable logic controller system enables fully automatic operation and highest efficiency. We offer an optional automatic de-ashing system for the highest level of cleanliness and comfort.

### Pellematic types and power ratings

We offer the Pellet boiler with the following power ratings:  
Suction-feed systems: 68,300; 109,500 and 191,000 BTU/hr

All sizes / outputs of the Autopellet boiler are available with external automatic ash compression system.

**Note:**

Refer to the data plate for the power rating of your Pellematic. The data plate is located on the rear side of the Pellematic. Here you will find the type designation, manufacturer's serial number and year of build.

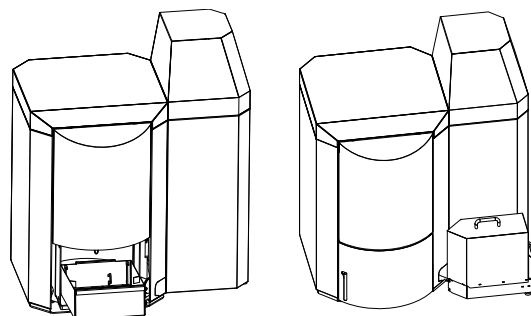

### Key components of the Pellematic

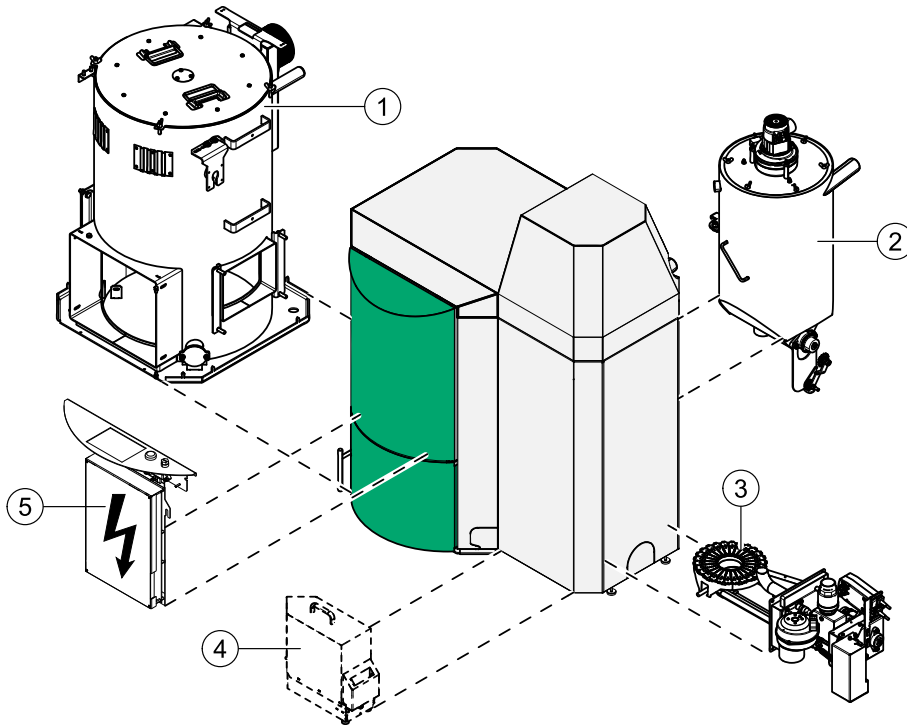

1	Boiler (heat exchanger)
2	Vac Hopper / Day tank
3	Burner
4	External automatic ash compression system
5	Boiler controller

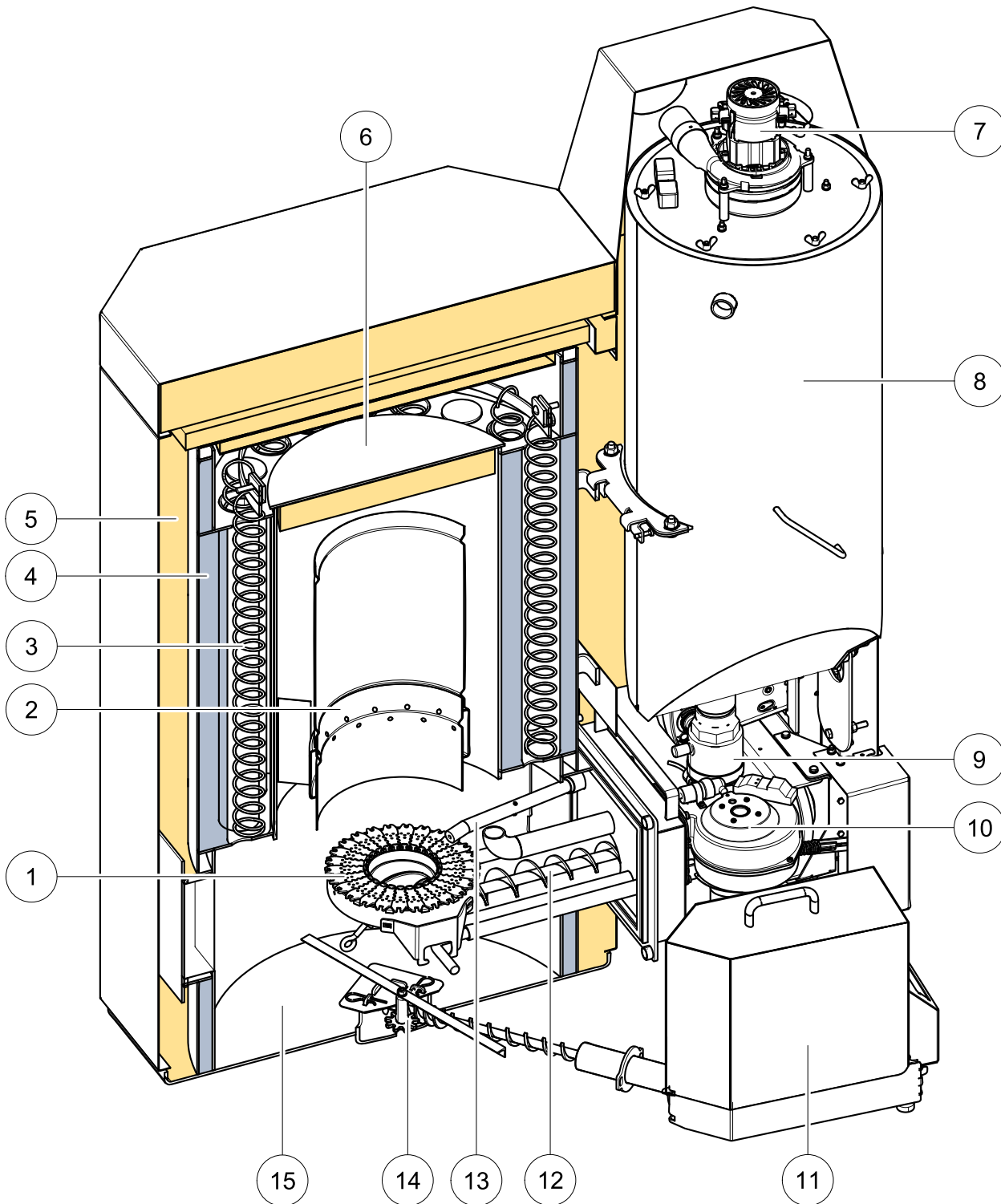

1	Burner plate	9	Fire protection - ball valve
2	Flame tube	10	Burner fan
3	Heat exchanger	11	External ash box
4	Boiler water	12	Burner auger
5	Boiler insulation	13	Electronic ignition
6	Combustion chamber cover	14	De-ashing system cover
7	Suction turbine	15	Ash chamber / Fire chamber
8	Vac hopper / Day tank		

## 7.2 Pellet suction system

The pellet suction system consists of the pellet line, air line and a suction fan. The suction fan in the hopper conveys pellets in the pellet line from the storage room or fabric tank to the hopper.

### Key components of pellet suction system

1	Pellet line	Line from the storage room auger or fabric tank to the hopper.
2	Air line	Line from the suction fan to the storage room auger or fabric tank.
3	Suction fan	Located above the hopper behind the Pellet boiler burner housing.
4	T-piece	Located at front end of the storage room auger, outside the storage room.
5	Suction flap	Located underneath the fabric tank.

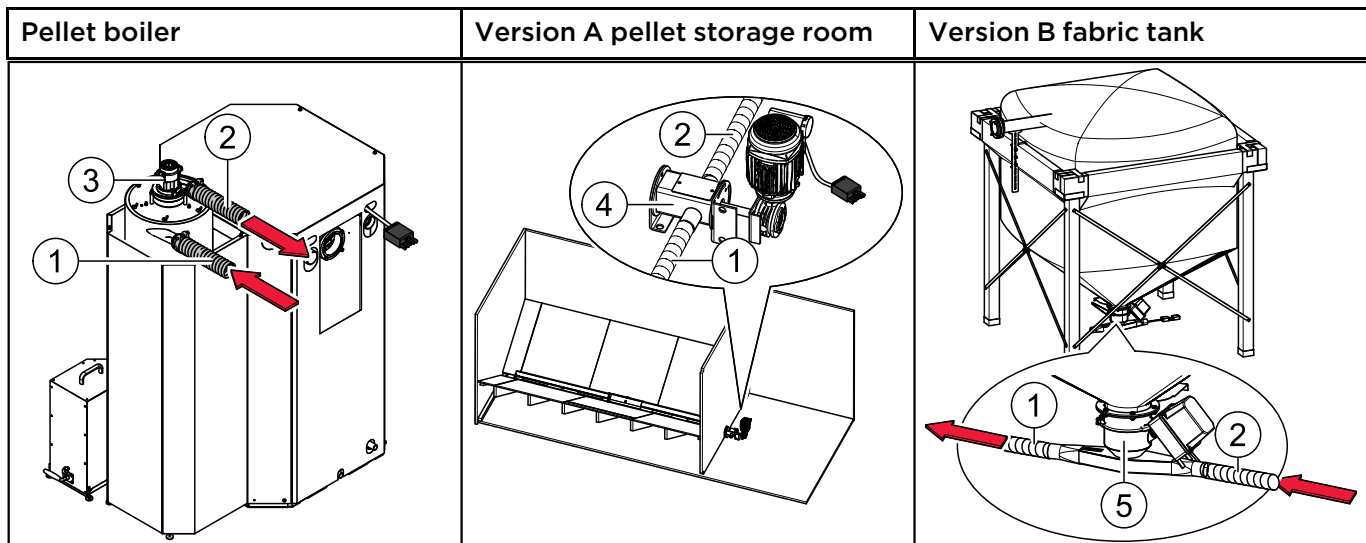

## 7.3 Auger delivery system

The auger system consists of: Delivery system motor, dropshaft, up leading auger with joint or extraction auger with extraction unit. The delivery system motor powers the auger system and transports pellets from the tank room or textile tank to the burner plate.

### Key components of the auger system

1	Up leading auger	Delivery auger with motor unit and joint (Connection of delivery auger and pellet boiler)
2	Extraction auger	Delivery auger with auger, emergency gate, supporting leg and handcuffs; (Connection of textile tank and pellet boiler)

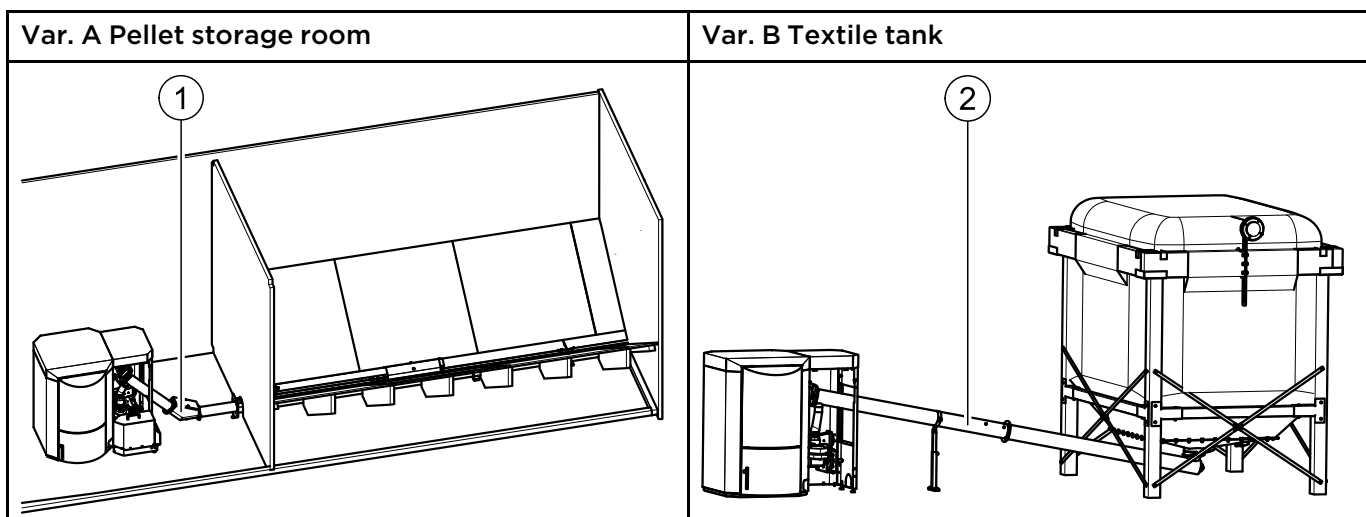

## 7.4 Storage systems

There are two methods for storing pellets: in a storage room with an auger feed system (version A) or in a FleXILO fabric tank (version B). FleXILO fabric tanks can be located inside the central heating room, storage room or protected from wet and sun outside.

### NOTICE

#### **Damage to property and loss of warranty**

The combination of an ÖkoFEN pellet boiler with a storage and conveyor system from another manufacturer is not permissible.

#### 7.4.1 Pellet storage room

The auger extraction system is part of the ÖkoFEN pellet heating system. The sloping base is to be provided by the customer. Information and important notes on setting up storage rooms can be found in the ÖkoFEN planning documents and on [www.oekofen.com](http://www.oekofen.com). Information on installing the auger extraction system is included in the auger system installation manual. Refer to the instructions on how to make a sloping base.

#### 7.4.2 Flexilo fabric tank

The whole fabric tank system is included in the scope of supply. ÖkoFEN offers various sizes and types. The fabric tank supplied may vary from the example shown above.

Please refer to the installation instructions supplied for the fabric tank. Note also the instructions on setting up and filling.

## 8 Operating the Pellematic

The pellet heating system is an automatic heating system. All pellet feed system and combustion system sequences are regulated automatically using an electronic boiler controller and heating controller.

### 8.1 Operating the heating system

#### NOTICE

Damage caused do to incorrect operation or incorrect settings.

Only trained operators may use the heating system. Make sure no unauthorised persons enter the central heating room. Keep children away from the central heating room and storage room.



#### DANGER

##### Fire risk

Keep the ash removal door closed while the boiler is in operation.

#### NOTICE

##### Standby mode boiler controller

Don't set the main switch of the boiler controller outside of the heating period to Off, because no buffer battery is used.



## 8.2 Description of the control panel

The control panel is located underneath the flap above the door of the boiler.

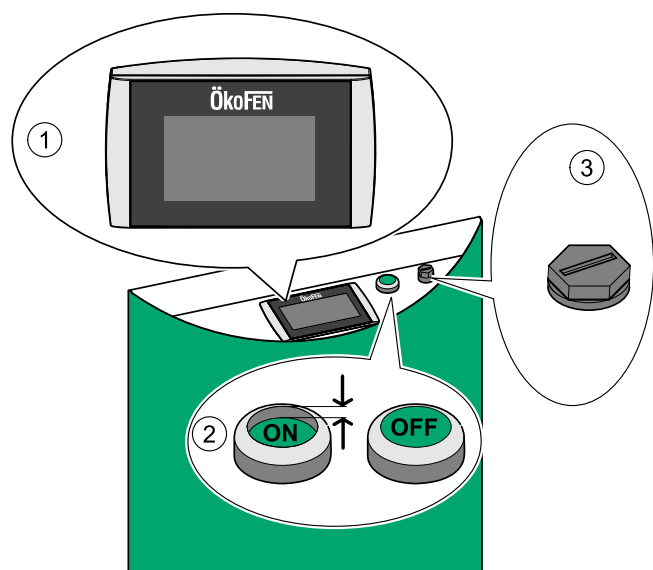

1	User control unit	Operates the boiler controller and the heating controller.
2	Main switch	Switches off the heating system (both poles) including the power supply to the control panel.
3	Safety temperature sensor	Switches the heating system off, if the boiler temperature reaches 230 °F. The heating controller remains active.

## 8.3 Setting language, date and time at Pelletronic Touch

**Setting the language** (The factory setting for the language is German)

Mittwoch, 10. Dezember 2014 10:44:15

Außentemperatur 31,6 °F  
Temperatur WW1 166,6 °F  
Kesseltemperatur PE1 72,9 °F  
Kesselstatus PE1 Aus



Messwerte Betriebsart Schornstein

Hauptmenü 10:44:02

Heizkreis 1 Heizkreis 2 Warmw Solar

PES Allgemein Firmware Code

Allgemeines

Schornstein Favoriten Wertauswahl Länderel

Störung Info ModBUS E-Mail

Länder-Einstellungen

Sprache Einheit  
Deutsch Imperial

Datum Uhrzeit  
10.12.2014 10:45:02

Länder-E

Spra  
D

Dat  
15.

Deutsch  
English  
français  
Nederlands  
italiano  
español  
čeština

Local Settings

Language Unit  
English Imperial

Date Time  
Dec 10, 2014 10:46:23 AM

**Setting the date**



**Setting the time**



## 8.4 Operating Device with Touch screen

The Touch operating device is mounted on the control board of Pellematic. The color display is surrounded by a foil design with logo. With finger pressure you make settings on the Touch operating device.

## 8.5 Opening window

The touch panel is dark during in standby mode. As soon as you touch the surface of the touch, light turns on and displays the opening window.

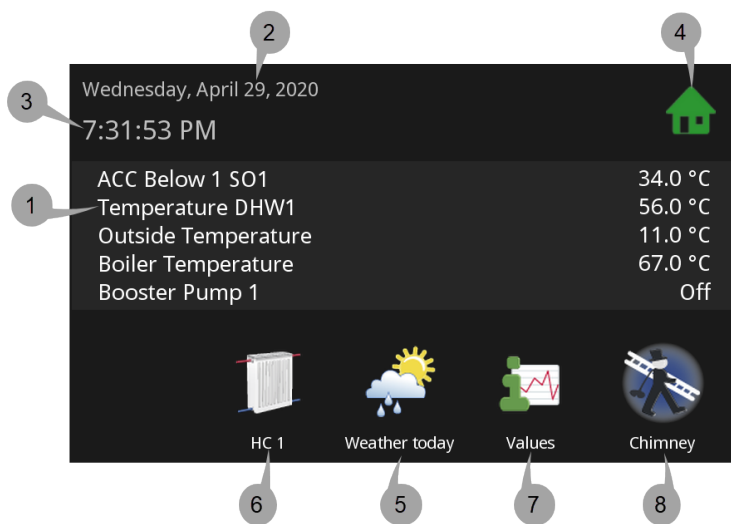

- 1 Measuring values (adjustable)
- 2 Date
- 3 Hour
- 4 The icon house takes to the main menu
- 5 Weather + display current weather (only when weather function is active)

**Note:**

If there is a malfunction, the corresponding fault message is displayed at this point instead of the weather icon

- 6 Favorite 1 (adjustable)
- 7 Favorite 2 (adjustable)
- 8 Favorite 3 (adjustable)

## 8.6 User controls and their function

### 1. Navigation-icons

Icon-  
view

If you touch an icon, the icon turns green. The green shows that you are currently on this icon. You get to the enabled menu item .



The yellow house enters you directly to the main menu.



The horizontal arrow leads you one step back.



With the blue down arrow you get to additional lines of information on this item. (Down - scroll down).



With the blue up arrow you get to additional lines of information on this item. (Top of page - scroll up)



You get to the respective menu item.

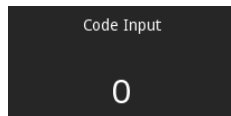

You get to the settings of the parameter. You come either to a numeric keypad, a time / date block or the text selection.

## 2. Numeric keyboard

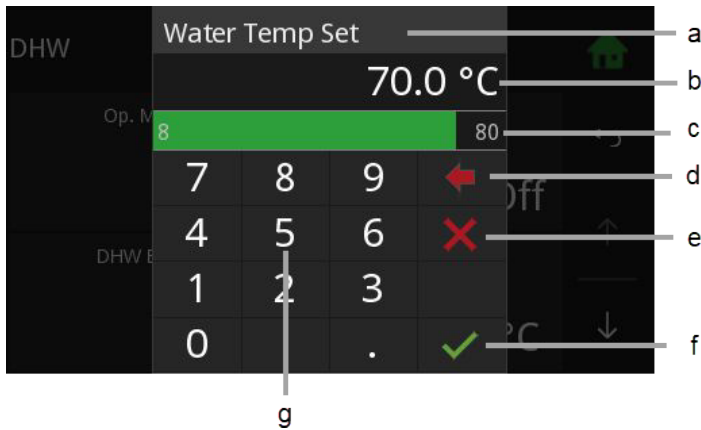

- a. Name of parameter
- b. Value of parameter with unit
- c. Min/max value - Values outside this range are not accepted.
- d. Delete input of numbers - per contact you delete one place.
- e. Cancel - You return to the menu item. Input of a new value was not accepted. The original value is.
- f. Help function - inactive
- g. Confirm
- h. Numeric keyboard - used to enter values within the min - max range.

## 3. Time and date block



- a. Adjustable time or date
- b. Cancel
- c. Help function - inactive
- d. Confirm

## 4. Text selection

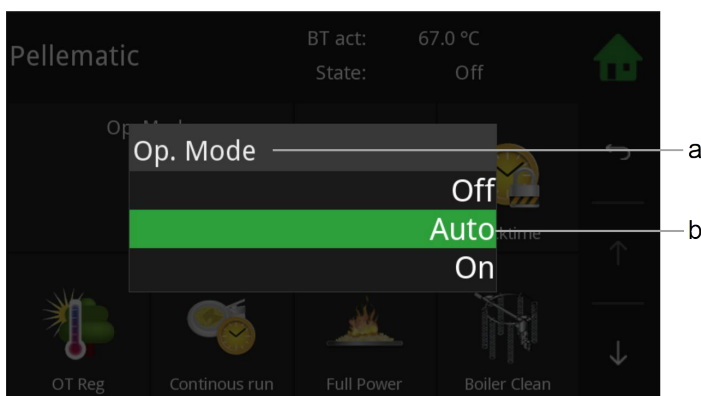

- a. Name of parameter
  - b. Status texts  
The number of status texts depends of the parameter.
- Choose a status text. The setup menu closes automatically and the chosen status text is displayed in the menu.

### Note:

Although a scroll down menu is open, the navigation icons, menu items and parameters behind are active and by touching them it takes you directly there.

## 8.7 Main Menu

In the Main menu you see all submenus. By finger pressure on an icon you reach the respective submenu.

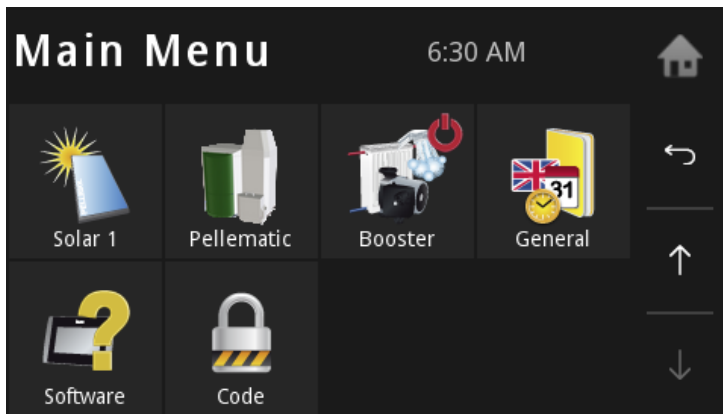

Menu navigation of Pelletronic Touch

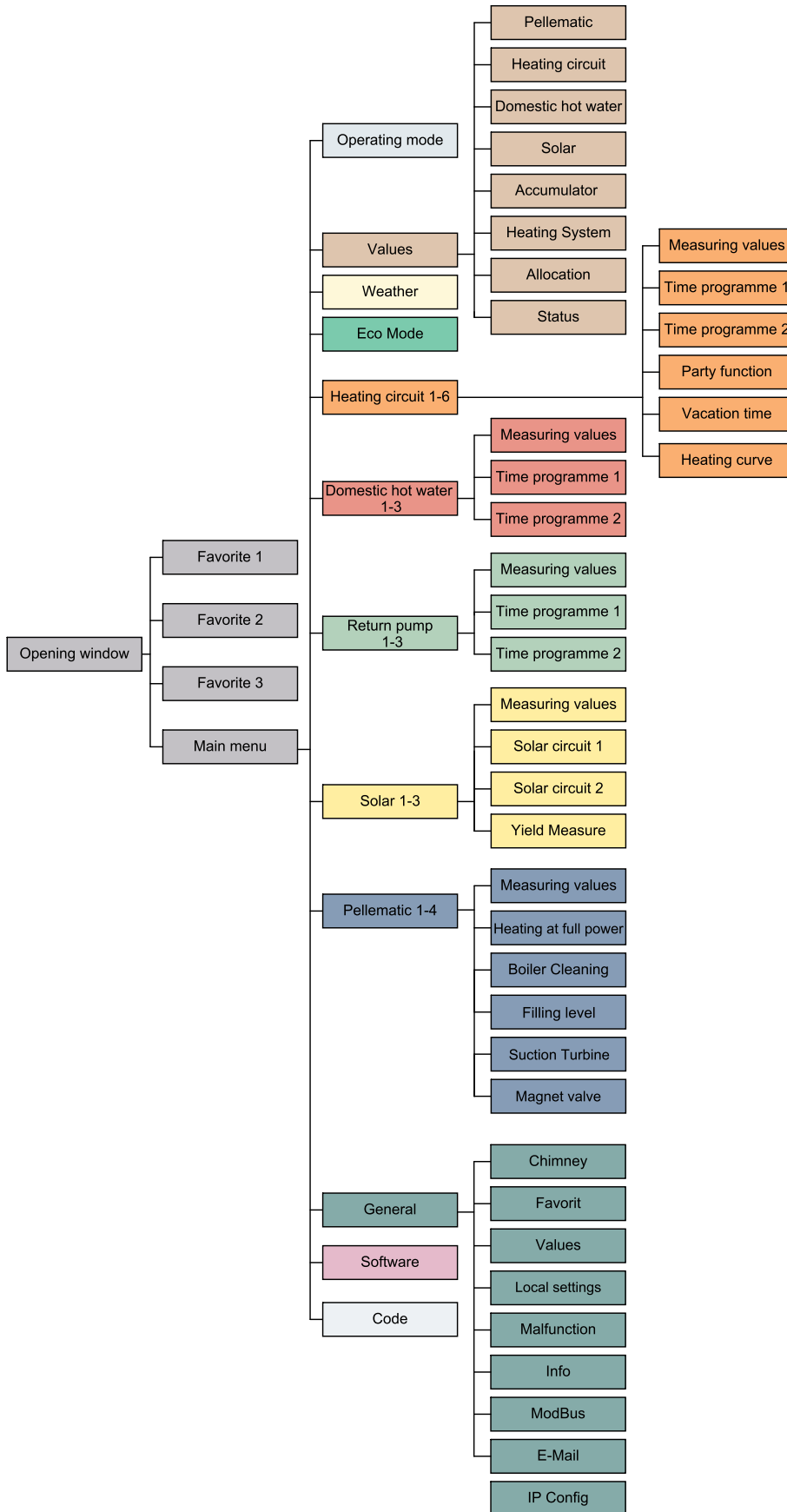



## 9 Mode

In the menu item Mode you can see the mode of your heating system and the mode of the heating circuits, domestic hot water and solar.



The menu item **Mode** is in the Main menu.

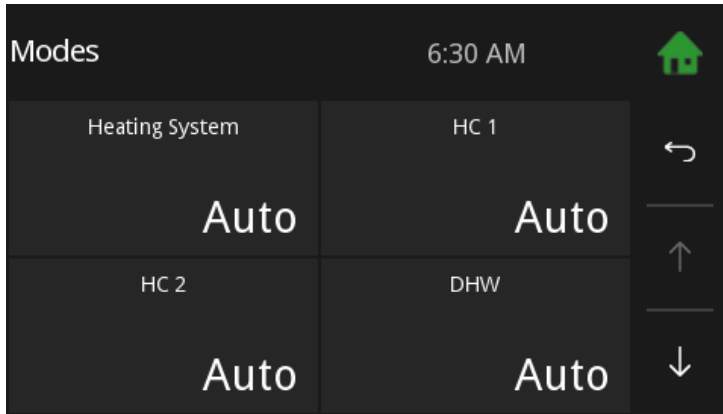

Overview of the operating modes

- Heating Plant
- Heating system 1-6 .
- Domestic hot water 1-3
- Solar 1-3

Choose the operating modes and make settings.

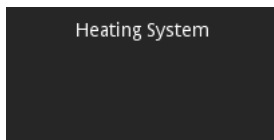

### Off

The adjusted operating mode of the heating circuits and DHW is inactive.  
The frost protection function is active.

### Auto

The adjusted operating mode of the heating circuits and DHW is active.  
The frost protection function is active.

### DHW

The adjusted operating mode of the DHW is active.  
The adjusted operating mode of the heating circuits is active.  
The frost protection function is active.

**The operating mode heating circuits, domestic hot water and solar are described in the respective chapters.**

# 10 Measuring Values

In the menu item of Measuring Values you see all actual and set values of your heating system.



The menu item **Measuring Values** is in the Main menu.

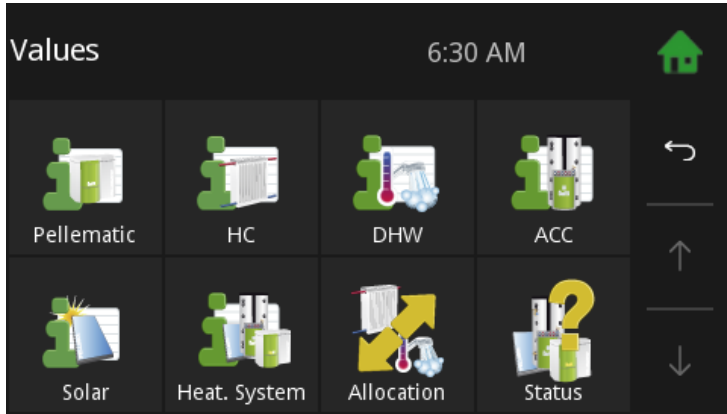

- Pellematic
- Heating circuit
- Domestic hot water
- Solar
- Accumulator
- Return pump
- Heating Plant

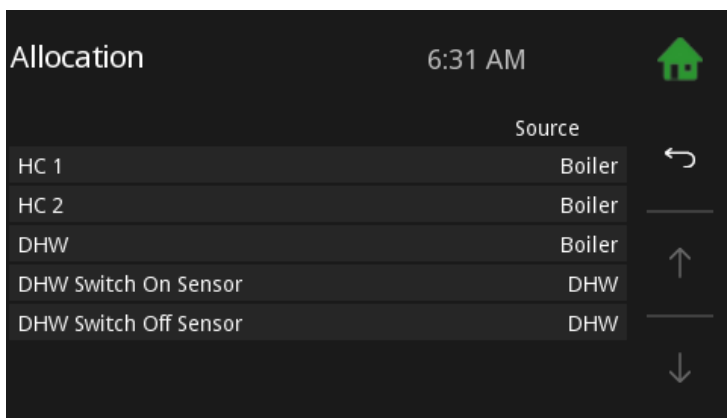

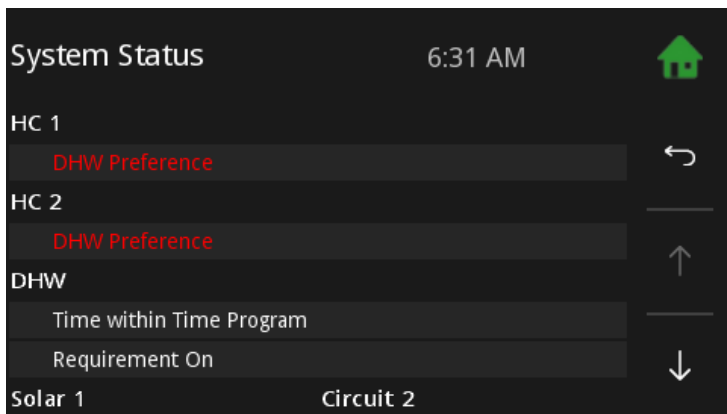

In the menu item **Allocation** you see which heating circuits are allocated to the boiler or to the accumulators.

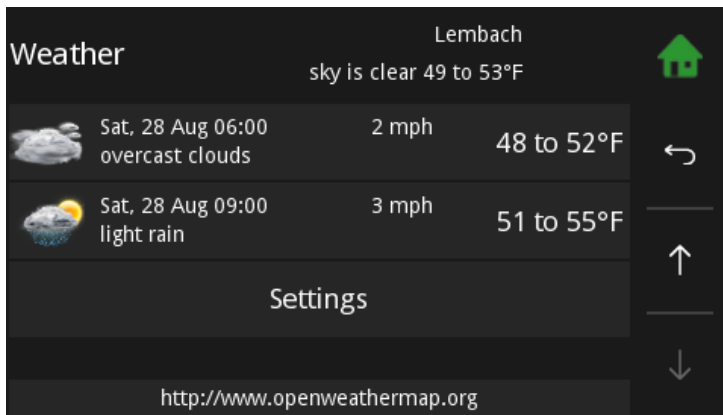

In the menu item **Status** you always have an overview about the whole heating system.

# 11 Weather



Choose **Settings** (  ), to enter your location.



Enter location and country. If the specified location is not found, enter a larger, nearby place.

Search with the following details:

- Postal code, location, country
- Postal code, country
- Location, country

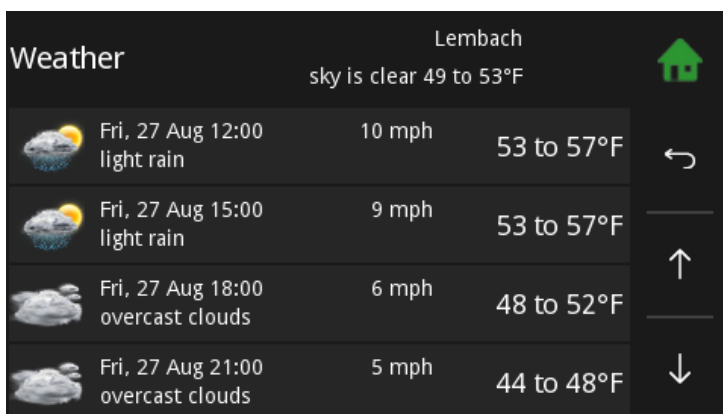

Afterwards, weather data for the next 3 days are downloaded. An icon for the current weather is displayed on the opening window.

**Note:**

This feature requires an internet connection.

# 12 Heating Circuit

**Heating Circuit** encloses all for heating relevant parameters and settings. It can occur up to 6 menu items **Heating Circuit**.



**Heating Circuit** is in the Main menu

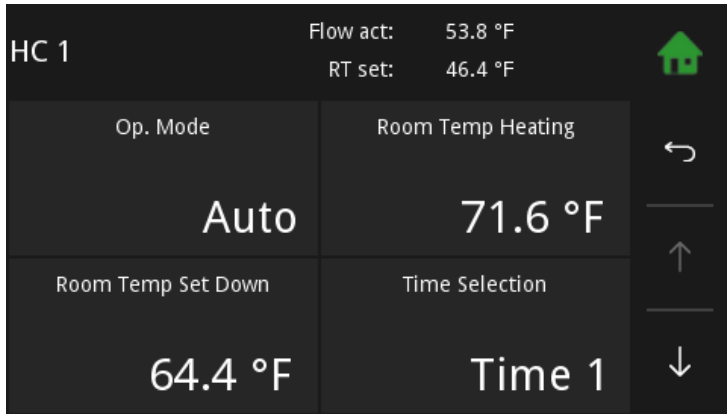

Heating circuits settings has following menu items:

- Mode
- Room Temp Heating
- Room Temp Set back
- Time Allocation
- Values
- Time 1
- Time 2
- Party
- Vacation
- Heatingcurve

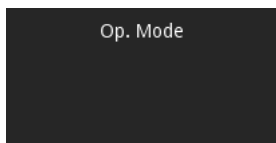

**Off** Only the frost protection function is active.

**Auto** The Furnace starts in the heating times according to the Set room temperature.

**Heating** The Furnace heats constantly according to the Set room temperature.

**Set back** The Furnace heats constantly according to the Set back room temperature.

The operating mode of the heating circuits can only be changed if the plant operating mode is set to AUTO.

The adjusted heating limits and maximum flow temperatures are used in all operating modes.

Choose your room temperature (Temperature within the heating times).

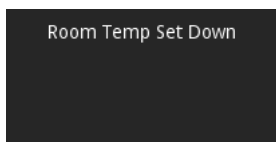
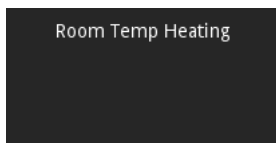

Choose Room Temp Set back (= Minimum temperature beyond the heating times).

## 12.1 Measuring values Heating circuit



Measuring values HC is in the Main menu.

Values		7:36 PM	
↳ HC		0 / 5	
Outside Temperature	11.0 °C		
Boiler Temperature	67.0 °C	70.0 °C	
Burner Contact	On		
HC1 Flow Temperature	45.0 °C	8.0 °C	
HC1 Room Temp	21.3 °C	8.0 °C	
HC1 Pump	Off		
HC1 Mixer	Off		

You see all to the Heating circuit corresponding measuring values:

- Actual value
- Set value
- Inputs (sensors)
- Outputs (pumps, mixer and motors)

<b>Outside Temperature</b>	actual Outside Temperature
<b>Boiler Temp</b>	actual Boiler Temperature
<b>Booster</b>	Status (Booster On/Off)
<b>Flow Temp</b>	display of the flow temperature
<b>Room Temp</b>	display of the room temperature
<b>Pump</b>	Status (Pump On/Off)
<b>Mixer</b>	Status (Mixer On/Off)

## 12.2 Time programme Heating circuit

In the heating circuit time programme you fix the heating times.



**Time 1 (=Time programme 1)** and **Time 2** are in the menu Heating circuit.

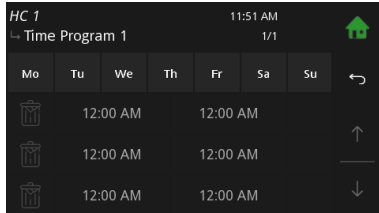

**1** Select Time programme 1

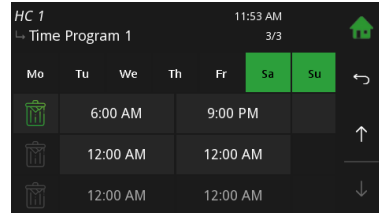

**6** Mo-Fr were assigned heating times

With you get to the remaining days Sa-Su.

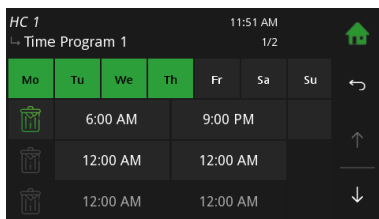

**2** Select the heating days. The activated days are deposited in green.

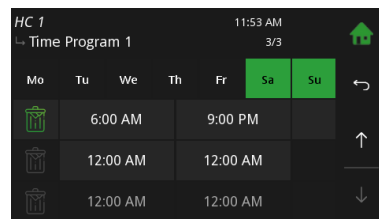

**7** Sa-Su were assigned to heating times.

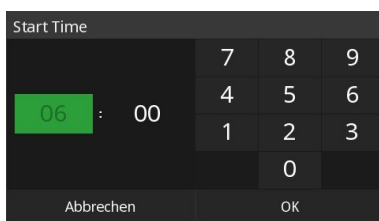

**3** Enter the heating times for these heating days (Mo-Th).

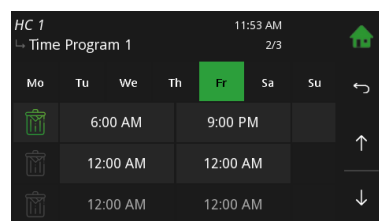

**8** With and you switch between the heating blocks. You can deactivate heating days in the heating block and activate in another.

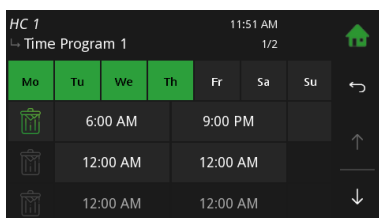

**4** The heating times for Mo-Th are assigned. With you assign to days heating times further.

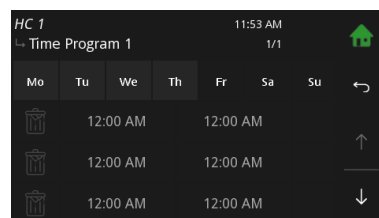

**9** With you set all the heating times in the line and below to 0.

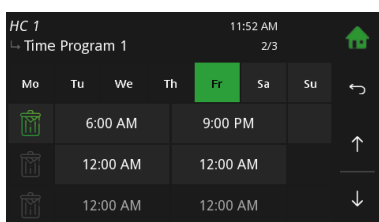

**5** Friday was activated. Heating times were assigned.

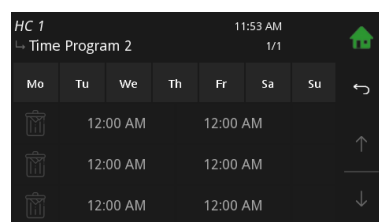

**10** Go back with . Choose Time 2. For every heating circuit there are 2 time programmes. You can programme 2 time programmes. In the menu item **Time Allocation** you can activate time 1 or time 2.

## 12.3 Party

The party function extends the heating time once, without changing the heating times.



**Party** is in the Main menu.

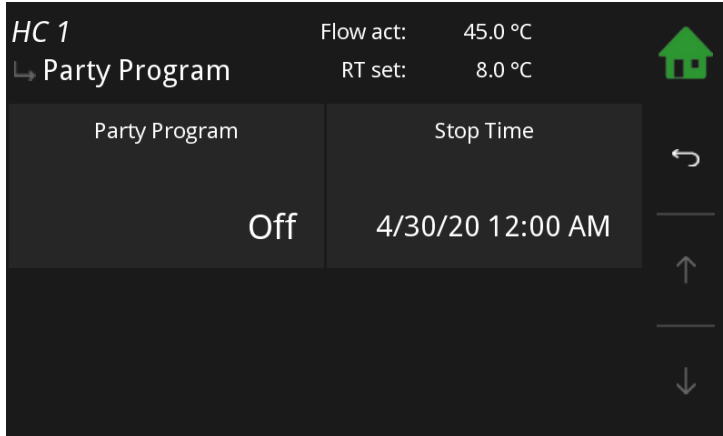

The party function is basically inactive. Enter the time until the room temperature heating should be heated. Activate the Party function. The heating time is extended up to the indicated time. Then the party function deactivates itself automatically.

## 12.4 Vacation

The holiday programme cancels the heating times and heats for the entered period on the set temperature level.



**Vacation** is in the Main menu.

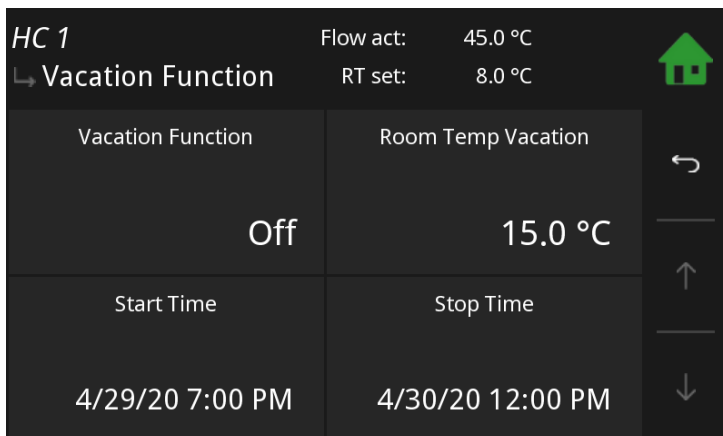

Enter the room temperature on which in your absence the building should be heated. Enter the departure (start time) and return (finish date) and activate the vacation programme.

**Note:**

To return in an already tempered building, you must enter the day before the return as the finish date.

## 12.5 Heating curve and Heating limits

By starting up the first time, the authorised technical adviser adjusts the heating curve, the base point and the heating limits on the building situation and the hydraulics. If the Set room temperature is not reached or exceeded, adjust the heat curve with the flow temperatures according to outside temperatures.



Heating curve is in the menu Heating circuit.

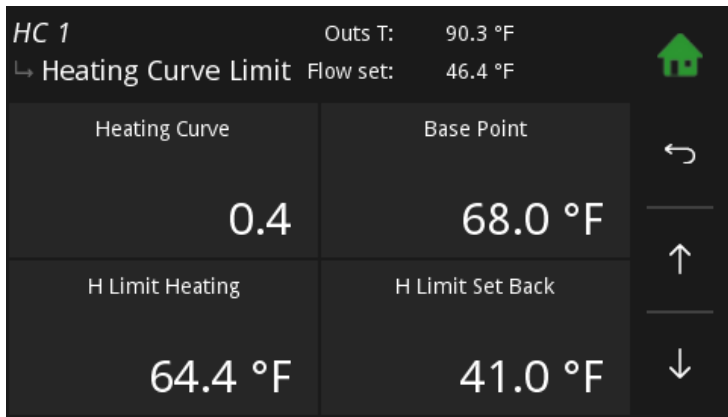

### Heating curve 0.0 - 4,0

The heating curve describes the combination between outdoor temperature and the associated flow temperature for a heating circuit.

#### Base point adjustable from 68 - 113°F

With the change the of base point, you provide a parallel shift of the heating curve.

#### H limit heating

If the average outside temperature is higher than the set temperature, the heating circuit switches off in the heating mode.

#### H limit set temperature

If the average outside temperature is higher than the set temperature, the heating circuit switches off in the Set back mode.

### Adjustment of heating curve and the base point to the building

Because of the building’s thermal inertia, it is recommended to perform no more than one adjustment step per day.

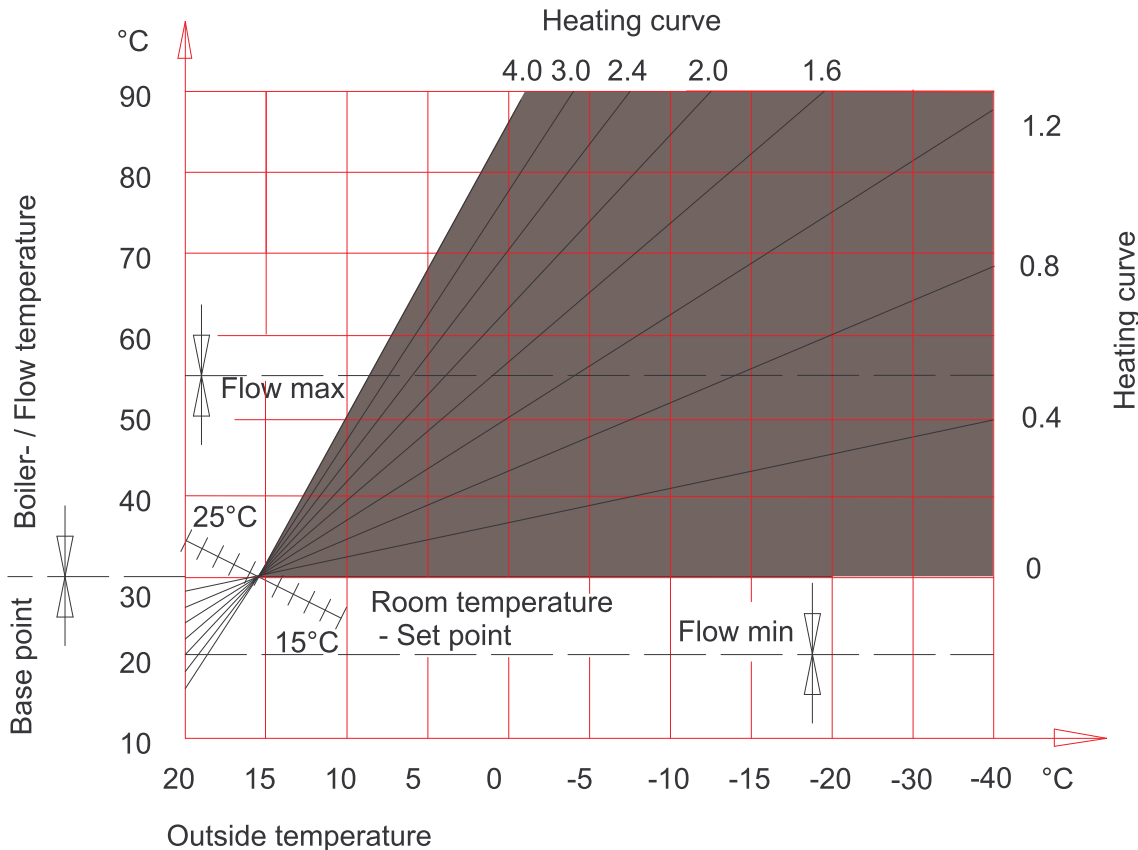



Daytime outside temp	Room temperature	
	too warm	too cold
+5 to +15°C	Decrease heating curving value by 0,2	Increase heating curving value by 0.2
	Decrease base point value by 5°	Increase base point value by 5°
-20 to +5°C	Decrease heating curve value by 0.2	Increase heating curve value by 0.2

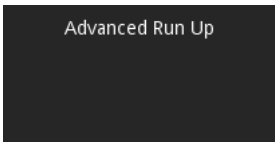

The advanced run up indicates how long the system has to heat before the start of the heating time, to reach the adjusted **roomtemp heating**.

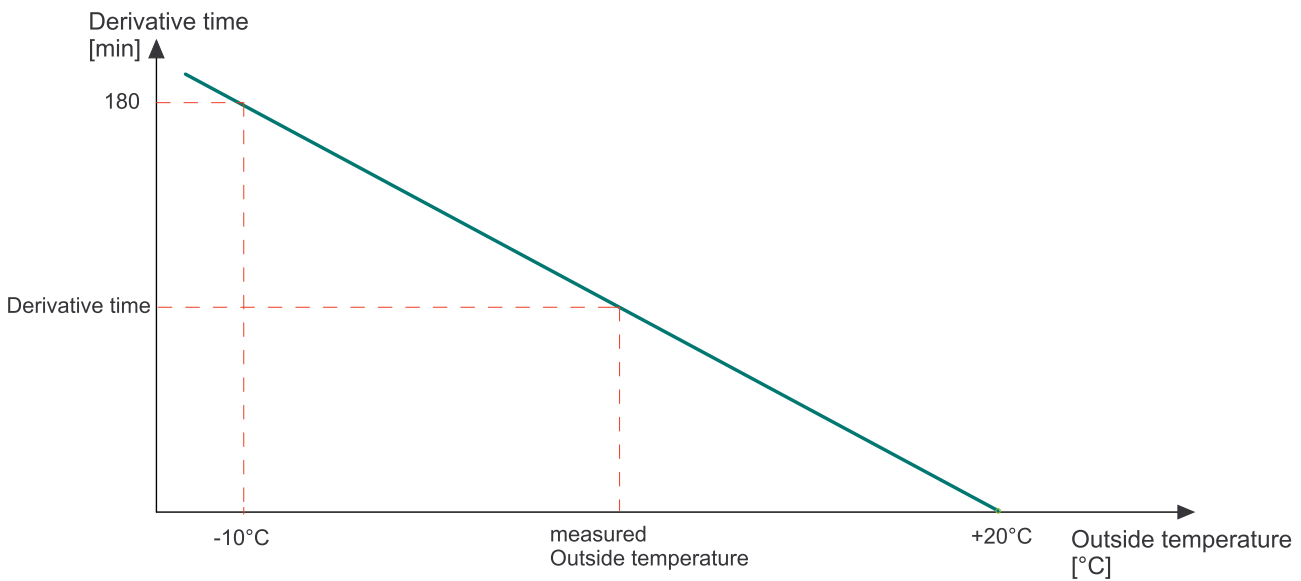

**Room thermostat influence**

If the measured room temperature deviates from the set room temperature, the heating controller corrects the flow temperature with the Room thermostat influence. The Room thermostat influence indicates how much the flow temperature is raised or lowered so that the Set room temperature is reached.

**Example:**

Room temperature desired value = 20°C

Room temperature actual value = 18°C

Room sensor influence = 3

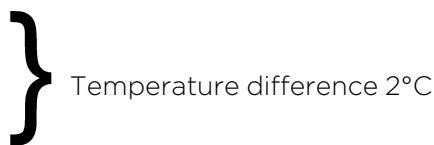

<b>Room sensor influence</b>	*	<b>Temperature difference</b>	=	<b>Advanced run up rise/reduction</b>
<b>3</b>	*	<b>2</b>	=	<b>6°C</b>

### Room temperature hysteresis

The Room temperature hysteresis prevents the cycling (On Off On Off...) of the heating circuit pump: If the Set room temperature + room temperature hysteresis is reached, the associated pump stops. If the Set room temperature is  $-1^{\circ}\text{C}$ , the pump switches on again.

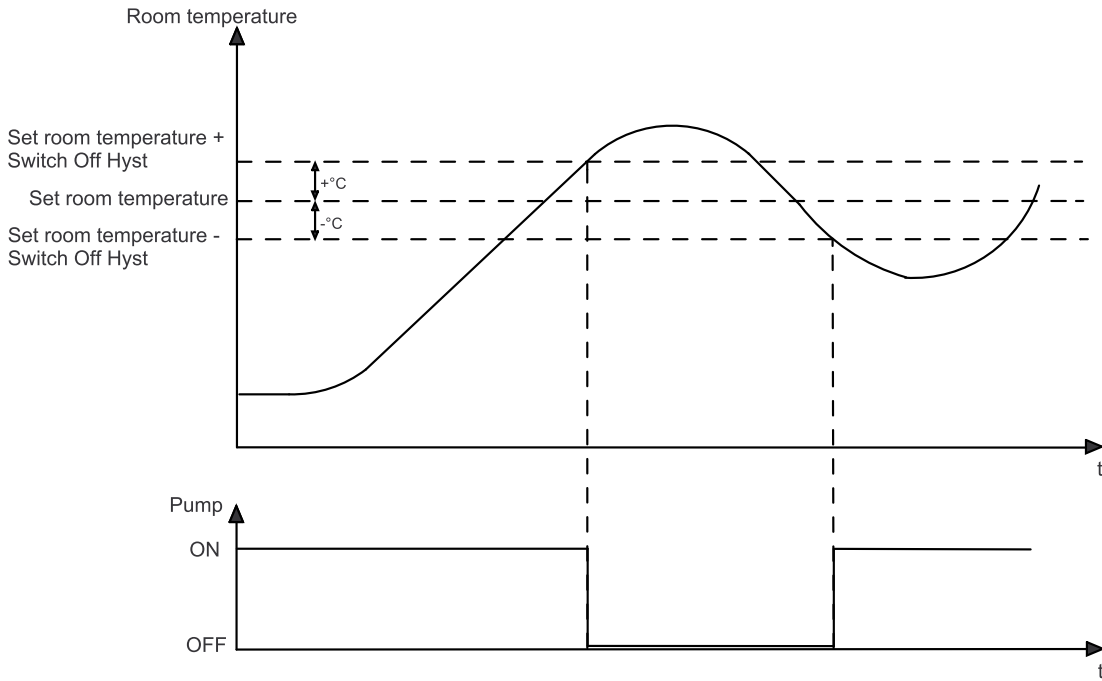

# 13 Domestic hot water

The menu Item **Domestic hot water** contains up to 3 submenu items.

Domestic hot water includes all, for the preparation of hot water, relevant parameters and settings.



**Domestic hot water** is in the main menu.

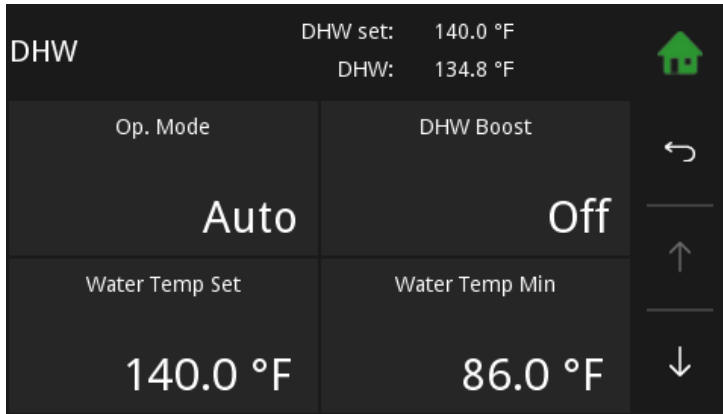

DHW settings has following menu items:

- Mode
- DHW Boost
- Water Temp Set
- Water Temp Min
- Time programme
- Values
- Time 1
- Time 2

Op. Mode

**OFF** Set water temperature is reduced to 46 °F for frost protection.

**Auto** The installation heats the water within the time programme to the **desired hot water temperature**. Outside the time programme the installation heats to **Watertemp min**

**On** The system heats up the domestic hot water continuously on the Water temp set.

You can change the mode domestic hot water only when the **Operation mode** is on **AUTO**.

Heats the hot water once on the Water temp set.

DHW Boost

Water Temp Set

Set the water temperature.

Water Temp Min

Set the minimum water temperature. The water temperature never falls below this value, unless the domestic hot water mode is on **OFF**.

Time Selection

Activate **Time 1** (= Time programme 1) and **Time 2**.



You are able to see a list of all measuring values that are involved in the menu domestic hot water.



In the DHW time programme you set the times of the hot-water processing. The DHW time programme works the same way like the heating circuit time programme. See chapter [12.2 Time programme Heating circuit, page 38](#)

## 13.1 Measuring values Domestic hot water



**Measuring values DHW** is in the Main menu.

Values		7:38 PM		0 / 5	
↳ DHW					
Outside Temperature	11.0 °C				
Boiler Temperature	67.0 °C	70.0 °C			
Burner Contact	On				
DHW1 Temperature	56.0 °C	60.0 °C			
DHW1 Pump	On				
ACC1 TPO	72.0 °C	8.0 °C			
ACC1 TPM	65.0 °C	8.0 °C			

You see all the Heating circuit corresponding measuring values:

- Actual value
- Set value
- Inputs (sensors)
- Outputs (pumps, mixer and motors)

## 13.2 Time programme DHW

In the DHW time programme you set the times for the hot-water processing.



**Time 1 (=Time programme 1)** and **Time 2** are in the menu **Domestic hot water**.

DHW 1		7:38 PM		1 / 1		
↳ Time Program 1						
Mo	Tu	We	Th	Fr	Sa	Su
	6:00 AM				9:00 PM	
	12:00 AM				12:00 AM	
	12:00 AM				12:00 AM	

The domestic hot water time programme works the same way like the heating circuit time programme.

# 14 DHW Return pump



**DHW Return pump** is in the Main Menu.

The Return pump enables the immediate DHW tap of the water taps. DHW Return pump has following menu items:

- Mode
- Switch off temperature
- Switch on hysteresis
- Time allocation
- Values
- Time 1
- Time 2

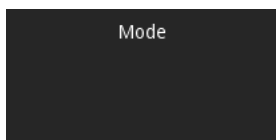
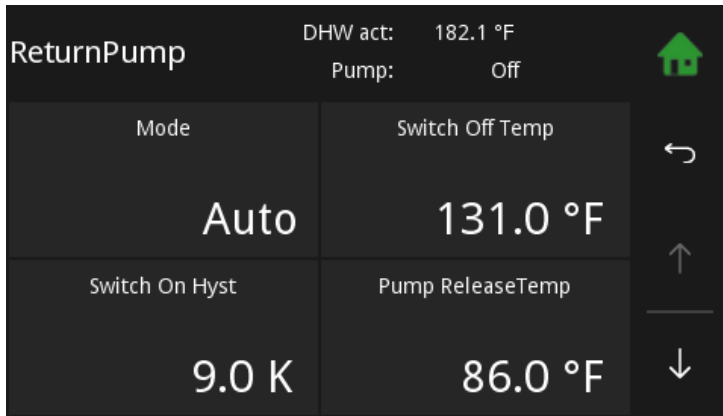

**Off** DHW Return pump inactive

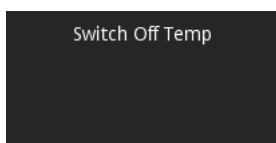

**Auto** Temperature regulation within the time programme

If the return temperature sensor of the DHW Return pump reaches the **Switch off temperature**, the pump switches off.

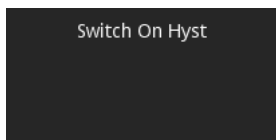

If the return temperature falls below the switch off temperature – the DHW Return pump switches on again!

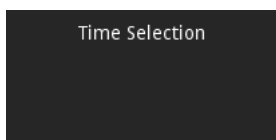

Choose the time programme 1 or 2.

You see all the DHW pump corresponding measuring values.



Set the run times of the Return pump. The return pump – time programme works the same way like the heating circuit time programme.

**Note:**

A **Return Pump** and a **booster** rule out each other.

## 14.1 Measuring values DHW Return pump



Measuring values DHW Return pump is in menu DHW Return pump.

Values		12:04 PM	
↳ ReturnPump		0 / 5	
Outside Temperature	6.9 °C		
Boiler Temperature	26.3 °C	8.0 °C	
Burner Contact	Off		
Existing Boiler	61.0 °C		
Switching Valve	On		
SHHT-1#58EFD0#	50.5 %	25.5 °C	
SHEM-3#DC4F22764744#	0.0 W	0.0 W	

You see all the Heating circuit corresponding measuring values:

- Actual value
- Set value
- Inputs (sensores)
- Outputs (pumps, mixer und motors)

## 14.2 Time programme DHW return pump

In the Time Programme DHW Return Pump you set the times for the hot water in the water purchasers.



Time 1 (=Time programme 1) and Time 2 are in the menu DHW return pump.

ReturnPump		12:04 PM					
↳ Time Program 1		1/1					
Mo	Tu	We	Th	Fr	Sa	Su	
		6:00 AM			9:00 PM		
		12:00 AM			12:00 AM		
		12:00 AM			12:00 AM		

The DHW return pump time programme works the same way like the heating circuit time programme.

# 15 Solar

Solar includes all relevant parameters and settings for the solar thermal system. You can control up to 6 solar circuits.



**Solar** is in the Main menu.

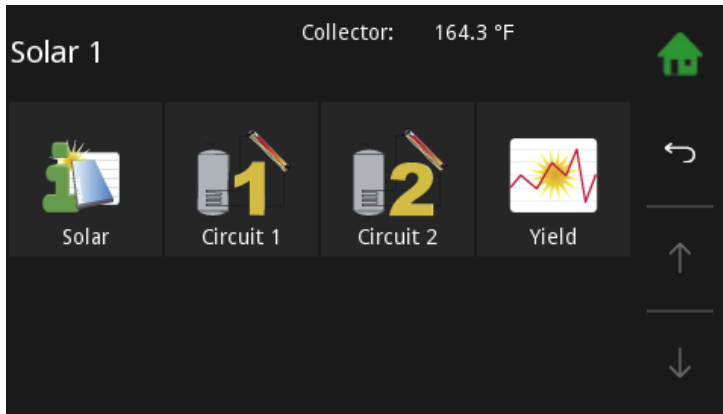

Solar has following menu items:

- Measuring values Solar
- Solar circuit 1-2
- Solar energy- yield

## 15.1 Measuring values Solar



**Measuring values Solar** is in the menu Solar.



It displays all measuring values of Solar:

- Actual values
- Set values
- Inputs (sensors)
- Outputs (pumps, mixer and motors)

## 15.2 Solar circuit



Solar circuit 1 and 2 are in menu Solar.

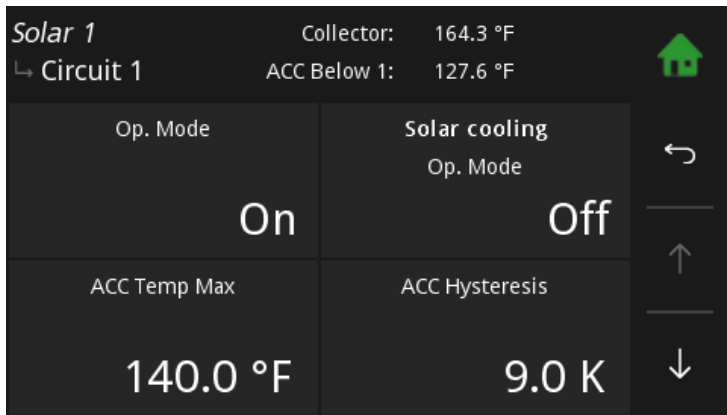

Solar circuit has following menu items:

- Operation Mode
- ACC Temp Max
- ACC Hysteresis
- Collector Hyst On
- Collector Hyst Off

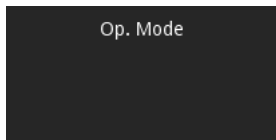

**Off:** No charge

**On:** Charge as long as **Collector temperature + hysteresis** is lower than the temperature of the **Adj ACC sensor below** or the **ACC temp max**

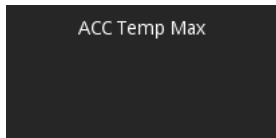

If the temperature in the ACC is higher than the ACC temp Max, the solar pump switches off. The limit sensor measures the temperature in the ACC.

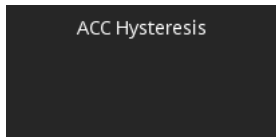

The solar circuit pump is switched off due to the ACC temp Max is reached. The temperature must fall under ACC temp Max minus hysteresis, then the solar circuit pump switches on again. The hysteresis prevents a solar pump cycling (On Off On Off).

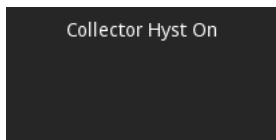

If the temperature difference between the collector sensor and TPU, ACC lower sensor is higher than the Coll Hyst A, the solar pump switches On.

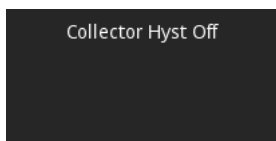

If the temperature difference between the collector sensor and TPU, ACC lower sensor is lower than the Coll Hyst A, the solar pump switches Off.

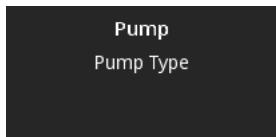

The menu **Pumptype** contains the following modes:

**Asynchronous:** Asynchronous pump – direct output 230VAC on/off

**Async.Regulated:** Asynchronous pump – pulsed output 230VAC

**Heating Efficient:** PWM1 - PWM signal inverted

**Solar Efficient:** PWM2 - PWM direct signal

**Note:**

When using a A-class pump as **Accumulator pump** the pump cannot be regulated from Solar circuit 2.

NOTICE

Material damage by false selection of pump!



## 15.3 Yield - Solar Energy

This function measures the yield of the solar thermal system and displays current energy and logs previous days.

For the function solar energy it is necessary to install:

- Pulse volume meter (must be connected to **24 VOLT** and **Z\_IN**)
- Flow temperature sensor
- Return temperature sensor



**Yield - Solar Energy** is in the menu Solar.

Solar 1		Collector:	164.3 °F
↳ Yield Measure			
Current			0.0 kW
Yield - Day			0.0 kWh
Yield - Day Before			0.0 kWh
Yield Since	1/1/12		0.0 kWh
Flow Rate			0.00 l/min
Flow Temperature			155.3 °F
Return Temperature			132.1 °F

Yield measuring of solar energy has following menu items:

- Actual  
Display of the current solar energy, refreshes every 60 sec.
- Yield - Day  
Display of todays solar energy since 00:00.
- Yield - Day before  
Display of yesterdays solar energy.
- Yield since  
Display of the solar energy since the last set date.
- Flow rate  
Display of the current flow rate, refreshes every 60 sec.
- Flow temperature  
Display of the current flow temperature
- Return temperature  
Display of the current return temperature

# 16 Pellematic

Pellematic includes all the relevant parameters and settings for the control of the pellet boiler. There are up to 4 Pellematic boilers possible.



**Pellematic** is in the Main menu.

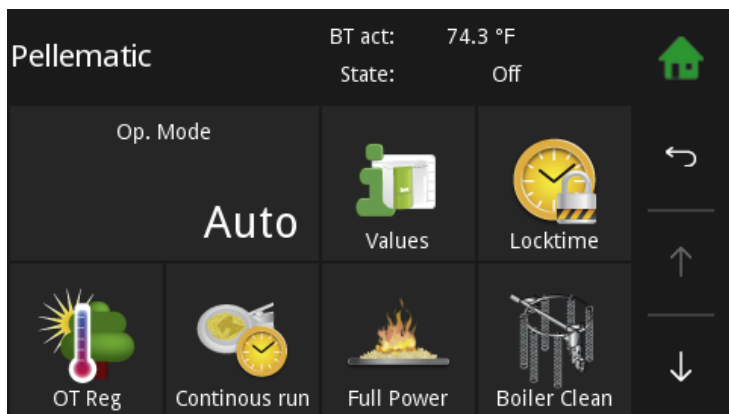

## 16.1 Measuring values



**Measuring values** is in the menu Pellematic.

Values		7:27 AM	
Pellematic		1 / 5	
Outside Temperature	90.3 °F		
Boiler Temperature	74.3 °F	46.4 °F	
Burner Contact	Off		
Existing Boiler	141.8 °F		
Switching Valve	On		
SHHT-1#F3AD7E#	32.0 °F		
ACC1 TPO	124.9 °F	46.4 °F	

It displays all measuring values of Pellematic:

- Actual values
- Set values
- Inputs (sensors)
- Outputs (pumps, mixer and motors)

## 16.2 Full Power



**Full Power** is in the menu Pellematic

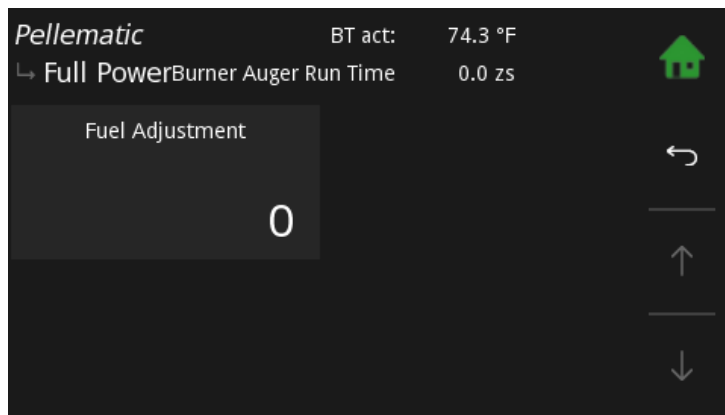

In the menu item Full Power can you adjust the fuel feed.

### **Fuel Adjustment:**

The burner auger run time is calculated automatically by the PLC depending on the rated power and the boiler setpoint temperature. The burner motor is controlled accordingly. You can reduce or increase the value calculated by the PLC 10 steps up or down.

## 16.3 Boiler cleaning

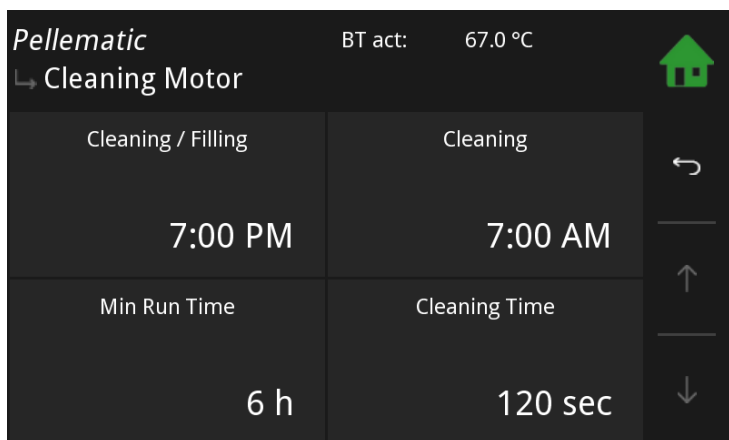

### Cleaning / Filling

The value to be set is the time (full hour) at which the boiler cleaning sequence is performed. On vacuum systems the hopper is also filled at the same time, regardless of whether it is empty or not.

### Cleaning

You can set in **Cleaning/Filling** a second cleaning sequence. The value to be set is the time (full hour) at which the additional boiler cleaning sequence is performed. Example: 20h = additional boiler cleaning sequence performed at 20:00. On vacuum systems the hopper is also filled at the same time, regardless of whether it is empty or not.

Default value -1h: It is not performed a second cleaning sequence.

### Min Run Time

Min Run Time of the boiler until next cleaning sequence. Value adjustable.

### Cleaning Time

Duration of the boiler cleaning sequence in seconds. Value adjustable.

## 16.4 Level detection system



**Weight system** (Menu is only displayed when the function Network is activated in the menu General.



Threshold

The threshold value, **Minimum weight** for a warning message, is adjustable. The warning message appears on the operating device and will be terminated when filling level rises above the adjusted Minimum weight.

**Note:**

Only displayed if mode is set on **Textile tank**

## 16.5 Suction turbine

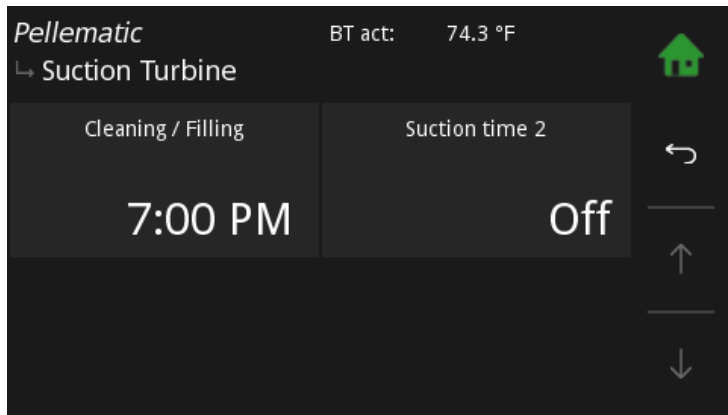

Cleaning / Filling

Set a Time (full hours), at which the hopper gets refilled, regardless how full it is at this time.

At the same time the purification of the boiler will take place.

Suction time 2

**On**

When this menu point is activated, a field appears for specifying the 2nd daily suction time.

**Off**

No 2nd suction time

# 17 General

General includes the complete heating control related settings and individual operating options for the customer.



**General** is in the Main menu.

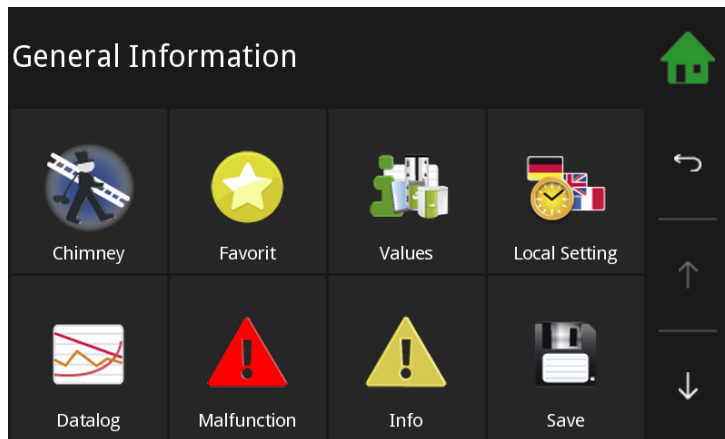

The menu **General** includes:

- Chimney
- Favorit
- Values
- Local setting
- Datalog
- Malfunction
- Info
- Save
- Load
- ModBUS
- E-Mail
- IP Config
- Settings

## 17.1 Chimney

The function chimney is only for chimney draughts and authorized service technicians. It is used for the measurement of exhaust gas.

### Note:

The Chimney Sweep function is inactive without the Pelletronic Heating Controller.



The menu item **Chimney** is situated in the menu General.

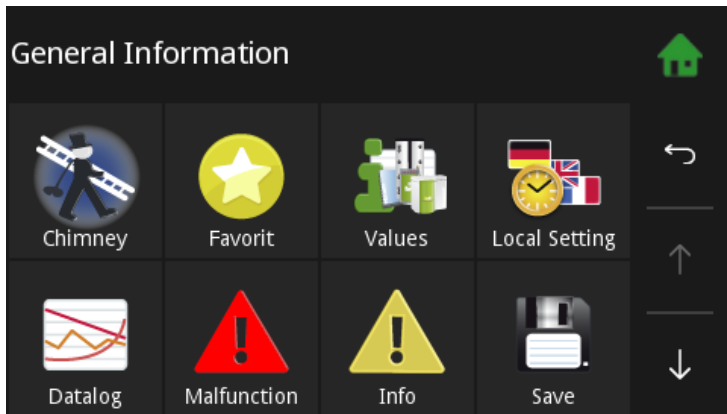

Please choose the function **Chimney**.

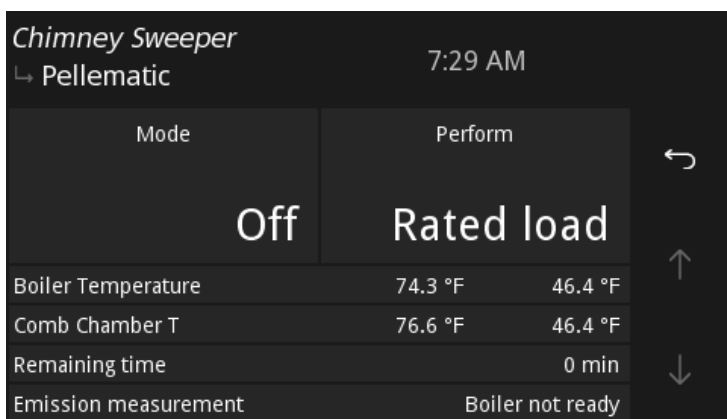

- The Furnace temperature is set to 140 °F for a total runtime of 30 minutes.
- You also can see actual Furnace temperature and the rest of the time limit.
- After the expiry of the time limit the function chimney ends. time of expiry the operation Chimney sweeper ends.
- The button Cancel ends the function Chimney.

## 17.2 Favorite



**Favorite** is in the menu General.

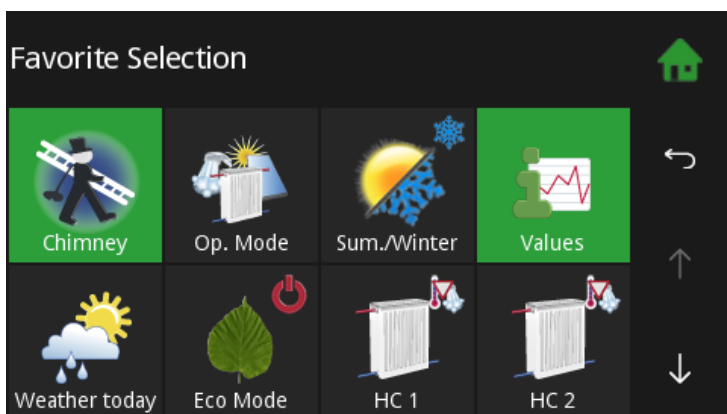

With this function you can display most commonly used menus in the start menu. This enables you a direct access. Select the menu item that should be displayed as a favorite 1 in the Start menu.

The selected item is green and the icon is displayed in the Start menu and is active.





## 17.3 Local Settings



**Local Settings** is in the menu General.

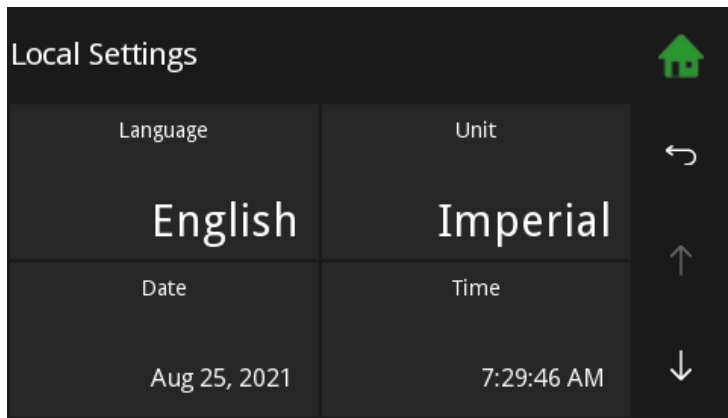

Local Settings has following menu items:

- Language
- Unit
- Date
- Time

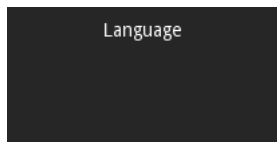

Choose between the languages German, English UK, English U.S. French, Spanish, Italian, Dutch, Danish and Russian.

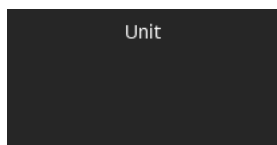

You can choose between isometric and imperialist number system.

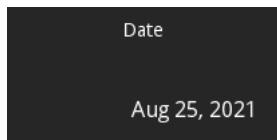

Set the current date.

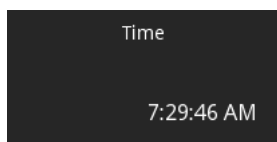

Set the current time.

## 17.4 Malfunction



**Malfunction** is in the menu General.



Fault messages can be overlaid on all menu items and appear immediately if a fault occurs. Every fault message appears with the date, time and name on the display. It remains until it is acknowledged.

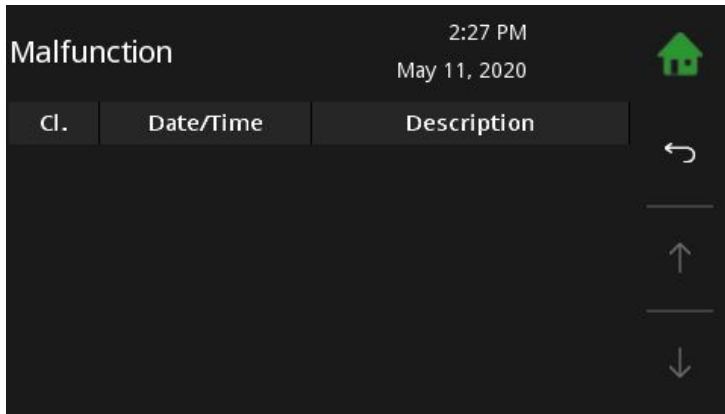

The menu remains the fault incident reports, as long as they are corrected up.

### 17.4.1 Malfunction report

This is a list of all malfunction reports on the display.

Code	Display	Input / Output		Affected element	Solution table
1001	HC1 Flow BC	X4 or X5		Heating controller	13.1a
1002	DHW1 OnSensor BC	X6			
1003	Outside Sensor BC	X2			
1004	Boiler Sensor BC	X3			
1008	TPO1 BC	X7			
1009	TPM1 BC	X8			
1010	Collektor1 BC	X15		Heating controller	13.2a
1011	TPU1 BC	X9 or X10		Heating controller	13.1a
1012	Flow Energy1 BS	X16			
1013	Return Energy1 BS	X17			
1014	ExistBoiler1 BS	X13			
1017	Cascade OnSensor BC	X3 or X7			
1018	Cascade OffSensor BC	X3 or X8			
1019	Circulation Return1 BC	X14			

Code	Display	Input / Output		Affected element	Solution table
1020	DHW1 Off Sensor BC	X6 or X7, X8, X9			
2001	HC1 Flow SC	X4 or X5		Heating controller	13.1b
2002	DHW1 OnSensor SC	X6			
2003	Outside Sensor SC	X2			
2004	Boiler Sensor SC	X3			
2008	TPO1 SC	X7			
2009	TPM1 SC	X8			
2010	Collektor1 SC	X15			
2011	TPU1 SC	X9 or X10		Heating controller	13.1b
2012	Flow Energy1 SC	X16			
2013	Return Energy 1 SC	X17			
2014	ExistBoiler1 SC	X13			
2017	Cascade OnSensor SC	X3 or X7			
2018	Sonde arrêt cascade CC	X3 or X8			
2019	Circulation Return1 SC	X14			
2020	DHW1 Off Sensor SC	X6 or X7, X8, X9			
3001	HC1 Flow	X4 or X5		Heating controller	13.1c
3002	DHW1 OnSensor	X6			
3003	Outside Sensor	X2			
3004	Boiler Sensor	X3			
3008	TPO1	X7			
3009	TPM1	X8			
3010	Collektor1	X11			
3011	TPU1	X9 or X10		Heating controller	13.1c
3012	Flow Energy1	X16			
3013	Return Energy1	X17			
3014	ExistBoiler1	X13			
3017	Cascade OnSensor	X3 or X7			
3018	Cascade OffSensor	X3 or X8			
3019	Circulation Return1	X14			
3020	DHW1 Off Sensor	X6 or X7, X8, X9			
4005	BUS HCR 1	X1A or X1B		BUS-Network RS485	13.3
4006	BUS PE 1	X1A or X1B			
4007	BUS Remote 1	X1A or X1B			
4015	BUS Remote Touch 1	X1A or X1B			
4016	BUS Master	X1A or X1B			
4021	BUS Radio Remote 1	X1A or X1B			
5000	PE1 Reserve sensor1 BS	R1		Boiler Controller	13.1a
5001	PE1 Reserve sensor1 SC	R1		Boiler Controller	13.1b
5002	PE1 Reserve sensor2 BS	R2		Boiler Controller	13.1a

Code	Display	Input / Output		Affected element	Solution table
5003	PE1 Reserve sensor2 SC	R2		Boiler Controller	13.1b
5004	PE1 Outside sensor BS	AF		Boiler Controller	13.1a
5005	PE1 Outside sensor SC	AF		Boiler Controller	13.1b
5006	PE1 Boiler sensor BS	KF		Boiler Controller	13.1a
5007	PE1 Boiler sensor SC	KF		Boiler Controller	13.1b
5008	PE1 Fluegas sensor BS	RGF		Boiler Controller	13.4
5009	PE1 Fluegas sensor SC	RGF			
5010	PE1 Combustion sensor BS	FRT			
5011	PE1 Combustion sensorSC	FRT			
5012	PE1 Underpressure box BS	UP		Boiler Controller	13.5
5013	PE1 Underpressure box SC	UP			
5014	PE1 Analog input1 BS	AE1		Boiler Controller	13.6
5015	PE1 Analog input1 SC	AE1			
5016	PE1 Analog input2 BS	AE2			
5017	PE1 Analog input2 SC	AE2			
5018	PE1 Motor turbine	VAK		Boiler Controller	13.7
5019	PE1 Ignition	ZUEND		Boiler Controller	13.8
5020	PE1 Motor ashbox	AV		Boiler Controller	13.9
5021	PE1 Motor res 1	RES1		Boiler Controller	13.10
5022	PE1 Magnetic valve	MA		Boiler Controller	13.8
5023	PE1 Motor cleaning	RM			
5024	PE1 Flue gas fan	SZ		Boiler Controller	13.9
5025	PE1 Cirkulationspump	UW			
5026	PE1 Motor ext auger1	RA		Boiler Controller	13.11
5027	PE1 Motor ext auger2	ZW		Boiler Controller	13.9
5028	PE1 Motor between	RES1		Boiler Controller	13.12
5029	PE1 Motor boiler auger	ES		Boiler Controller	13.9
5030	PE1 Combustion Fan	LUFT			
5032	PE1 Emergency stop	NOT		Boiler Controller	13.13
5033	PE1 Max temp sensor	STB			
5034	PE1 Ignition fault	generic		Boiler Controller	13.14
5036	PE1 Low flame temp				
5038	PE1 Firedamper open	BSK 1 2		Boiler Controller	13.15
5039	PE1 Firedamper closed	BSK 3 4			
5040	PE1 Firedamper end switch	BSK 1 2 3 4			

Code	Display	Input / Output		Affected element	Solution table
5041	PE1 Low underpressure	UP, SZ, LUFT		Boiler Controller	13.5
5042	PE1 Low underpressure	UP, SZ, LUFT			
5043	PE1 Vacuum system	KAPZW, RA		Boiler Controller	13.16
5044	PE1 Ashbox full	ESAV, AV		Boiler Controller	13.17
5045	PE1 Ball lock	DE1		Boiler Controller	13.18
5047	PE1 Burner Motor	ES		Boiler Controller	13.19
5048	PE1 Burner gas open-circuit	RGF		Boiler Controller	13.4
5049	PE1 Burner gas short-circuit				
5052	PE1 Container cover open	AK		Boiler Controller	13.20
5053	PE1 ash warning	ESAV, AV		Boiler Controller	13.17
5054	PE1 pellets warning	AE1		Boiler Controller	13.21
5055	Error Output VAK	VAK		Boiler Controller	13.22
5056	Error Output ZUEND	ZUEND		Boiler Controller	13.23
5057	Error Output AV	AV		Boiler Controller	13.24
5058	Error Output RES2	RES2		Boiler Controller	13.25
5059	Error Output MA	MA		Boiler Controller	13.26
5060	Error Output RA	RA		Boiler Controller	13.27
5061	Error Output SM	SM		Boiler Controller	13.28
5062	Error Output SZ	SZ		Boiler Controller	13.29
5063	Error Output UW	UW		Boiler Controller	13.30
5064	Error Output LUFT	LUFT		Boiler Controller	13.31
5065	Error Output RA1	RA1		Boiler Controller	13.32
5066	Error Output RES1	RES1		Boiler Controller	13.33
5067	Error Output ZW	ZW		Boiler Controller	13.34
5068	Error Output ES	ES		Boiler Controller	13.35

### 13.1a Sensors KTY2K - Heating controller + Boiler Controller (Fault 1001 to 1020 and 5000 to 5007) - Sensor break

Type of fault	Sensor break		
Code:	1001	HC1 Flow BC	X4
	1002	DHW1 OnSensor BC	X6
	1003	Outside Sensor BC	X2
	1004	Boiler Sensor BC	X3
	1008	TPO1 BC	X7
	1009	TPM1 BC	X8
	1011	TPU1 BC	X9
	1012	Flow Energy1 BS	X16
	1013	Return Energy1 BS	X17
	1014	ExistBoiler1 BS	X13
	1017	Cascade OnSensor BC	X3
	1018	Cascade OffSensor BC	X3
	1019	Circulation Return1 BC	X14
	1020	DHW1 Off Sensor BC	X6
	5000	PE1 Reserve sensor1 BS	R1
	5002	PE1 Reserve sensor2 BS	R2
	5004	PE1 Outside sensor BS	AF
	5006	PE1 Boiler sensor BS	KF
Description:	Measuring circuit of KTY sensor is open		
Cause and Remedy:	sensor not connected	▶	connect sensor, check plug
	sensor defect	▶	measure sensor (approx. 2kΩ at 77 °F) replace if required
	sensor cable defect	▶	replace sensor
	sensor temperature too high	▶	sensor temperature above measuring range (>230 °F)

### 13.1b Sensors KTY2K - Heating controller + Boiler Controller (Fault 2001 to 2020 and 5000 bis 5007) - short circuit

Type of fault	Short circuit		
Code :	2001	HC1 Flow SC	X4
	2002	DHW1 OnSensor SC	X6
	2003	Outside Sensor SC	X2
	2004	Boiler Sensor SC	X3
	2008	TPO1 SC	X7
	2009	TPM1 SC	X8
	2011	TPU1 SC	X9
	2012	Flow Energy1 SC	X16
	2013	Return Energy 1 SC	X17
	2014	ExistBoiler1 SC	X13
	2017	Cascade OnSensor SC	X3
	2018	Sonde arrêt cascade CC	X3
	2019	Circulation Return1 SC	X14
	2020	WW1 Aus Fühler KS	X6
	5001	PE1 Reserve sensor1 SC	R1
	5003	PE1 Reserve sensor2 SC	R2
	5005	PE1 Outside sensor SC	AF
5007	PE1 Boiler sensor SC	KF	
Description:	Measuring circuit of KTY sensor is shorted out		
Cause and Remedy:	Sensor defect	▶	Measure sensor (approx. 2k $\Omega$ at 77 °F), replace if required
	Sensor cable defect	▶	Replace sensor
	Sensor temperature too low	▶	Sensor temperature below measuring range (< 14 °F)



**13.1c Sensors KTY2K - Heating controller + Boiler Controller (Fault 3001 to 3020) - other faults**

Type of fault	Other faults		
Code:	3001	HC1 Flow	X4
	3002	DHW1 OnSensor	X6
	3003	Outside Sensor	X2
	3004	Boiler Sensor	X3
	3008	TPO1	X7
	3009	TPM1	X8
	3011	TPU1	X9
	3012	Flow Energy1	X16
	3013	Return Energy1	X17
	3014	ExistBoiler1	X13
	3017	Cascade OnSensor	X3
	3018	Cascade OffSensor	X3
	3019	Circulation Return1	X14
	3020	DHW1 Off Sensor	X6
Cause and Remedy:	Sensor defect	▶	Measure sensor (approx. 2kΩ at 77 °F), replace if required
	Sensor cable defect	▶	Replace sensor
	Sensor input defect	▶	Replace Boiler controller

**13.2 Kollektor sensor (Fault 1010, 2010, 3010)**

Display:	<b>[1010] Kollektor BC</b>		
Description:	Collector sensor fracture, measuring circuit of collector sensor (X15) is open		
Cause and Remedy:	Sensor not connected	▶	Check and correct wiring
	Sensor defect	▶	Measure sensor (approx. 1,1kΩ at 77 °F), replace if required
	Sensor cable defect	▶	Replace sensor
Display:	<b>[2010] Kollektor SC</b>		
Description:	Measuring circuit of collector sensor (X15) is shorted out		
Cause and Remedy:	Sensor defect	▶	Measure sensor (approx. 1,1kΩ at 77 °F), replace if required
	Sensor cable defect	▶	Replace sensor
Display:	<b>[3010] Kollektor</b>		
Description:	Other fault at input X15		
Cause and Remedy:	Sensor defect	▶	Replace sensor
	Sensor cable defect	▶	Replace sensor
	Input on heating controller defect	▶	Replace input on heating controller

**13.3 Bus (Fault 4005, 4006, 4007, 4015, 4016)**

Display:	<b>[4005] BUS HCR</b>		
Description:	Time-Out of BUS-connection from touch operating device to heating controller		
Cause and Remedy:	Wrong cable connection	▶	Check cable connection
	No power supply available	▶	Connect heating controller to BUS
	Fuse in heating controller defect	▶	Replace fuse
Display:	<b>[4006] BUS PE</b>		
Description:	Time-Out of BUS-connection from touch operating device to boiler controller		
Cause and Remedy:	Wrong cable connection	▶	Check cable connection
	No power supply available	▶	Connect heating controller to power supply (X21)
	Fuse in heating F2 defect	▶	Replace fuse F2
Display:	<b>[4007] BUS Remote</b>		
Description:	Time-Out of BUS-connection of remote control		
Cause and Remedy:	Wrong cable connection	▶	Check cable connection
	Remote controll defect	▶	Replace remote controll
Display:	<b>[4015] BUS Remote Touch</b>		
Description:	Time-Out of BUS-Connection from remote controll to Touch operating device		
Cause and Remedy:	Wrong cable connection	▶	Check cable connection
	Wrong softwareversion	▶	Check version of software
Display:	<b>[4016] BUS Master</b>		
Description:	Missing BUS connection to master-operating device		
Cause and Remedy:	Wrong cable connection	▶	Check cable connection

**13.4 Combustion chamber sensor (Fault 5010, 5011, 5048, 5049)**

Display:	<b>[5010] PE Combustion sensor BS</b>		
Description:	Combustion chamber sensor fracture, measuring circuit from combustion chamber sensor is open - Input FRT		
Cause and Remedy:	Sensor not connected	▶	Connect sensor at input
	Sensor defect	▶	Measure sensor (approx. 5 mV at 257 °F) replace if required
	Sensor cable defect	▶	Replace sensor
	Sensor temperature too high	▶	Sensor temperature above measuring range (2012 °F)
Display:	<b>[5011] PE Combustion sensor SC</b>		
Description:	Combustion chamber sensor short circuit, measuring circuit from combustion chamber sensor short circuit - Input FRT		

Cause and Remedy:	Sensor defect	▶	Measure sensor (approx. 5 mV at 257 °F) replace if required
	Sensor cable defect	▶	Replace sensor
	Sensor temperature too low	▶	Sensor temperature below measuring range (14 °F)
	Sensor polarity reversed	▶	Change sensor connection + and -
Display:	<b>[5048] PE Burner gas open-circuit</b> (only SMART without combustion chamber sensor)		
Description:	Burner gas sensor fracture, measuring circuit of Burner gas sensor is open - Output RGF		
Cause and Remedy:	Sensor not connected	▶	Connect sensor at input
	Sensor cable defect	▶	Replace sensor
	Sensor defect	▶	Measure sensor (NiCrNi) replace if required
	Sensor temperature too high	▶	Sensor temperature above measuring range (2012 °F)
Display:	<b>[5049] PE Burner gas short-circuit</b> (only SMART without combustion chamber sensor)		
Description:	Burner gas sensor short circuit, measuring circuit of Burner gas sensor short circuit - Output RGF		
Cause and Remedy:	Sensor defect	▶	Measure sensor (approx. 5mV at 257 °F) replace if required
	Sensor cable defect	▶	Replace sensor
	Sensor temperature too low	▶	Sensor temperature below measuring range (14 °F)
	Sensor polarity reversed	▶	Change sensor connection + and -

### 13.5 Underpressure box (Fault 5012, 5013, 5041, 5042)

Display:	<b>[5012] PE Underpressure box BS</b>		
Description:	Negative draft input open, measuring circuit from negative draft measurement open - Input UP		
Cause and Remedy:	Signal incorrect	▶	Check poarity and signal (0-10V)
	Signal cable defect	▶	Replace sensor
	No signal	▶	Replace underpressure box
	Combustion chamber leak	▶	Check total closure of boiler door

Display:	<b>[5013] PE Underpressure box SC</b>		
Description:	Negative draft input short-circuit, measuring circuit from negative draft measurement is shorted out - Input UP		
Cause and Remedy:	Signal incorrect	▶	Check poarity and signal (0-10V)
	Signal cable defect	▶	Replace sensor
	Signal too high	▶	Signal above 10V
Display:	<b>[5041] [5042] PE Low underpressure</b>		
Description:	Negative draft pressure in boiler is not achieved [5041] or is too high [5042] - Exit LUFT (SMART + Condens) / Output SZ (PE+PEK)		
Cause and Remedy:	Negative draft tube disconnected	▶	Connect up negative draft tube
	Negative draft does not change	▶	Check negative draft tube for leaks. Check flue gas tube for blockage.
	Negative draft pressure too low	▶	Close boiler door, check tube to negative draft sensor, check whether boiler flue gas outlet is clear, check whether condensation heat exchanger is clear. Make sure flue gas fan is running.
	Negative draft pressure too high	▶	Check induced draft blower

### 13.6 Analog input (Fault 5014, 5015, 5016, 5017)

Display:	<b>[5014] / [5016] PE Analog input 1/2 BS</b>		
Description:	Analog input 1/ 2 sensor fracture, measuring circuit of Analog input sensor open - Output AE1 / AE2		
Cause and Remedy:	Signal incorrect	▶	Check poarity and signal (0-10V)
	Signal cable defect	▶	Replace sensor
	Level detection system activated (valid for AE2)	▶	Check settings
Display:	<b>[5015] / [5017] PE Analog input 1 /2 SC</b>		
Description:	Analog input 1 / 2 sensor short circuit, measuring circuit of Analog input sensor is shorted out - Input AE1/AE2		
Cause and Remedy:	Signal incorrect	▶	Check poarity and signal (0-10V)
	Signal cable defect	▶	Replace sensor
	Signal too high	▶	Signal above 10V

**13.7 Motor turbine (Fault 5018)**

Display:	<b>[5018] PE Motor Turbine</b>		
Description:	Vaccuum turbine not running (Exit VAK)		
Cause and Remedy:	Motor unplugged	▶	Plug in motor, check cable connections
	Motor defect	▶	Replace motor
	Fuse F1, suction circuit board defective	▶	Replace fuse

**13.8 Output 230V (Fault 5019, 5022, 5023)**

Display:	<b>[5019] PE Ignition [5022] PE Magnetic valve [5023] PE Motor cleaning</b>		
Description:	No function of output ZUEND (Ignition)/MA (Magnetic valve)/ RM (Motor cleaning)		
Cause and Remedy:	Output unplugged	▶	Connect plug, check cable wiring
	Current value above the maximal Limit	▶	Check limits
	Current value under the minimal Limit	▶	Check limits

**13.9 Output 230V-2 (Fault 5020, 5024, 5025, 5027, 5029, 5030)**

Display:	<b>[5020] PE Motor ashbox (Output AV) [5024] PE Flue gas fan (Output SZ) [5025] PE Cirkulationspump (Output UW) [5027] PE Motor ext auger2 (Output RES2) [5029] PE Motor boiler auger (Output ES) [5030] PE Combustion Fan (Output LUFT)</b>		
Description:	No function of the respective motor/pump/fan		
Cause and Remedy:	Motor/pump/fan unplugged	▶	Connect plug, check cable wiring
	Motor/pump/fan defect	▶	Replace motor/pump/fan

**13.10 Zwischenbehälter leer - Motor res 1 (Fault 5021)**

Display:	<b>[5021] PE Hopper empty / Motor RES1 (for 36-56 kW, Pellematic Condens or PEB)</b>		
Description:	No function of PE motor res 1		
Cause and Remedy:	Motor unplugged	▶	Plug in motor, check cable connections
	Motor defect	▶	Replace motor
	No pellets available	▶	Refill storage-Room / supply tank

**13.11 Motor extraction auger 1 - RA (Fault 5026)**

Display:	<b>[5026] Motor ext auger1</b>		
Description:	Storage room auger 1 motor defect - Output RA		
Cause and Remedy:	Motor unplugged	▶	Plug in motor, check cable connections
	motor is jammed	▶	Remove pellets and dust from auger and make sure auger rotates freely
	Motor defect	▶	Replace motor
	Thermic contact triggered	▶	Let motor cool down
	Motor not running	▶	Check thermic contact

**13.12 Hopper motor (Fault 5028)**

Display:	<b>[5028] Hopper motor</b>		
Description:	Hopper suction fan fault. Output RES1.		
Cause and Remedy:	Motor unplugged	▶	Plug in motor, check cable connections
	Motor defect	▶	Replace motor

**13.13 Emergency OFF/ Safety temperature (Fault 5032, 5033)**

Display:	<b>[5032] Emergency OFF - NOT AUS</b>		
Description:	Emergency OFF has been actuated - Input NOT-AUS		
Cause and Remedy:	Emergency OFF unplugged	▶	Connect up Emergency OFF and check cable connections
	Emergency OFF button has been pressed	▶	Reset Emergency OFF switch
	Emergency OFF defect	▶	Replace Emergency OFF switch
Display:	<b>[5033] Safety temperature - STB</b>		
Description:	Safety temperature limiter has tripped - Input STB		
Cause and Remedy:	Safety temperature limiter unplugged	▶	Connect up safety temperature limiter and check cable connections
	Safety temperature limiter has tripped	▶	Let boiler cool down and reset safety temperature limiter
	Safety temperature limiter defect	▶	Replace safety temperature limiter
	A 230V Output is defect	▶	Check 230V Outputs

**13.14 Temperature Combustion chamber sensor/Flue gas sensor (Fault 5034, 5036)**

Display:	<b>[5034] PE Ignition fault / Pellets available?</b>		
Description:	Minimum temperature Combustion chamber sensor/Flue gas sensor not reached during the ignition phase		
Cause and Remedy:	No pellets available	▶	Fill up with pellets
	Ignition electrode defect	▶	Check ignition electrode (approx. 200Ω) replace if required
	Ignition nozzle blocked	▶	Clean burner plate and ignition tube

	Not enough draught	▶	Check ventilation flap, funktion radial fan, draught free
	Flue gas sensor or flamm-roomtemperature-sensor soiled	▶	Check Flue gas sensor or flammroom-temperature-sensor
Display:	<b>[5036] PE Flame supervision fault</b>		
Description:	Flame supervision fault, minimum flue gas temperature not reached during heating up at full power - Input FRT		
Cause and Remedy:	No pellets available	▶	Fill up with pellets

**13.15 Flame return gate BSK (5038, 5039, 5040)**

Display:	<b>[5038] PE Flame return gate open</b>		
Description:	Flame return gate open fault (BSK - 1 2)		
Cause and Remedy:	Flame return gate unplugged	▶	Connect up flame return gate and check cable connections
	Flame return gate does not reach OPEN limit switch	▶	Check ball valve to see if it is jammed
	No signal although open	▶	Check cables and flame return gate
	STB on the burner has triggered	▶	Surface temperature of the burner is too high
Display:	<b>[5039] PE Flame return gate closed</b>		
Description:	Flame return gate open fault		
Cause and Remedy:	Flame return gate unplugged	▶	Connect up flame return gate and check cable connections
	Flame return gate does not reach CLOSE limit switch	▶	Check whether ball valve is jammed, check ball valve throughway to see if foreign objects are preventing it from closing
	No signal although closed	▶	Check cables and flame return gate
	STB on the burner has triggered	▶	Surface temperature of the burner is too high. The boiler switches to fault mode.
Display:	<b>[5040] PE Flame return gate limit switch</b>		
Description:	Both flame return gate limit switches (BSK 1-2 and BSK 3-4) are closed at the same time		
Cause and Remedy:	Both limit switches activated	▶	Check flame return gate, check cables, check connectors

**13.16 Suction system (Fault 5043)**

Display:	<b>Suction system</b>		
Description:	Hopper cannot be filled up even after 3 suction cycles		
Cause and Remedy:	Storage room empty	▶	Fill up with pellets
	Extraction system is blocked	▶	Clear extraction system

	Extraction system not conveying pellets	▶	Pellet bridge - destroy bridge and make sure material flows properly
	Suction fan unplugged	▶	Connect up suction fan
	Storage room auger motor unplugged	▶	Connect up storage room motor

### 13.17 Ashbox full (Fault 5044) - Ash Warning (Fault 5053)

Display:	<b>[5044] PE Ashbox full</b>		
Description:	Moter doesn't reach the normal speed after 3 attempts.		
Display:	<b>[5053] PE Ash Warning</b>		
Description:	Ash-box nearly full		
Cause and Remedy:	Ash-box full	▶	Clear ash-box
	Ash-box not completely closed	▶	Close ash-box
	End-switch defect	▶	Replace end-switch

### 13.18 Ball lock (Smart and Condens only - Fault 5045)

Display:	<b>[5045] PE Ball lock - Smart and Condens only</b>		
Description:	No pellets detected from capacitive sensor (KAP RA)		
Cause and Remedy:	Pellet reserves depleted	▶	Refill storage-Room / supply tank
	Capacitive sensor RA defect	▶	Replace Capacitive sensor RA

### 13.19 Burner Motor / Ash box full (SMART and Condens only - Fault 5047)

Display:	<b>[5047] Burner Motor /Ash box full - SMART only</b>		
Description:	The alarm text is displayed after the motor has made 3 unsuccessful attempts to reach the normal speed of the external de-ashing system.		
Cause and Remedy:	Ash box is full	▶	Empty ash box
	Rotation of burner auger or ash auger is blocked	▶	Ensure rotation of auger

### 13.20 Container cover open (PEB only - Fault 5052)

Display:	<b>[5052] PE Container cover open</b>		
Description:	Container cover open (PEB only) - Input AK		
Cause and Remedy:	Cover open	▶	Close cover
	End-switch defect	▶	Replace end-switch

### 13.21 Pellets Warning (Fault 5054)

Display:	<b>[5054] PE 1 Pellets Warning</b>		
Description:	Measured pellets capacity (AE2) is below the threshold		
Cause and Remedy:	Pellets nearly empty or empty	▶	Fill up with pellets



---

	Sensor unpugged (AE2)	▶	Connect plug
	Parameter set incorrectly	▶	Check settings in menu Level detection system (protected access)

**13.22 Error Output VAK (Fault 5055)**

4005

Display:	<b>[5055] Error Output VAK</b>		
Cause and Remedy:	Output defect, incorrect wiring	▶	Check cable connection / Replace Boiler Controller

**13.23 Error Output ZUEND (Fault 5056)**

Display:	<b>[5056] Error Output ZUEND</b>		
Cause and Remedy:	Output defect, incorrect wiring	▶	VCheck cable connection / Replace Boiler Controller

**13.24 Error Output AV (Fault 5057)**

Display:	<b>[5057] Error Output AV</b>		
Cause and Remedy:	Output defect, incorrect wiring	▶	Check cable connection / Replace Boiler Controller

**13.25 Error Output RES2 (Fault 5058)**

Display:	<b>[5058] Error Output RES2</b>		
Cause and Remedy:	Output defect, incorrect wiring	▶	Check cable connection / Replace Boiler Controller

**13.26 Error Output MA (Fault 5059)**

Display:	<b>[5059] Error Output MA</b>		
Cause and Remedy:	Output defect, incorrect wiring	▶	Check cable connection / Replace Boiler Controller

**13.27 Error Output RA (Fault 5060)**

Display:	<b>[5060] Error Output RA</b>		
Cause and Remedy:	Output defect, incorrect wiring	▶	Check cable connection / Replace Boiler Controller

**13.28 Error Output SM (Fault 5061)**

Display:	<b>[5061] Error Output SM</b>		
Cause and Remedy:	Output defect, incorrect wiring	▶	Check cable connection / Replace Boiler Controller

**13.29 Error Output SZ (Fault 5062)**

Display:	<b>[5062] Error Output SZ</b>		
Cause and Remedy:	Output defect, incorrect wiring	▶	Check cable connection / Replace Boiler Controller

**13.30 Error Output UW (Fault 5063)**

Display:	<b>[5063] Error Output UW</b>		
Cause and Remedy:	Output defect, incorrect wiring	▶	Check cable connection / Replace Boiler Controller

**13.31 Error Output LUFT (Fault 5064)**

Display:	<b>[5064] Error Output LUFT</b>		
Cause and Remedy:	Output defect, incorrect wiring	▶	Check cable connection / Replace Boiler Controller

**13.32 Error Output RA1 (Fault 5065)**

Display:	<b>[5065] Error Output RA1</b>		
Cause and Remedy:	Output defect, incorrect wiring	▶	Check cable connection / Replace Boiler Controller

**13.33 Error Output RES1 (Fault 5066)**

Display:	<b>[5066] Error Output RES1</b>		
Cause and Remedy:	Output defect, incorrect wiring	▶	Check cable connection / Replace Boiler Controller

**13.34 Error Output ZW (Fault 5067)**

Display:	<b>[5067] Error Output ZW</b>		
Cause and Remedy:	Output defect, incorrect wiring	▶	Check cable connection / Replace Boiler Controller

**13.35 Error Output ES (Fault 5068)**

Display:	<b>[5068] Error Output ES</b>		
Cause and Remedy:	Output defect, incorrect wiring	▶	Check cable connection / Replace Boiler Controller

**17.5 Information**

**Information** is in the menu General.

Kl.	Zeit	St.	Beschreibung
⊖	06.06.17 03:45	Ⓢ	External Error [4022]
⊖	06.06.17 03:44	Ⓢ	External Error [4022]
⊖	06.06.17 03:43	Ⓢ	External Error [4022]
⊖	31.05.17 21:41	Ⓢ	BUS HCR 1 [4005]

In the menu item information are all faults listed chronologically.

The fault texts have 3 status

- C.....COME - when the fault occurs
- Q.....QUIT - when the fault has been rectified
- G.....GONE - when the fault has been reset by pressing ENTER

## 17.6 ModBUS

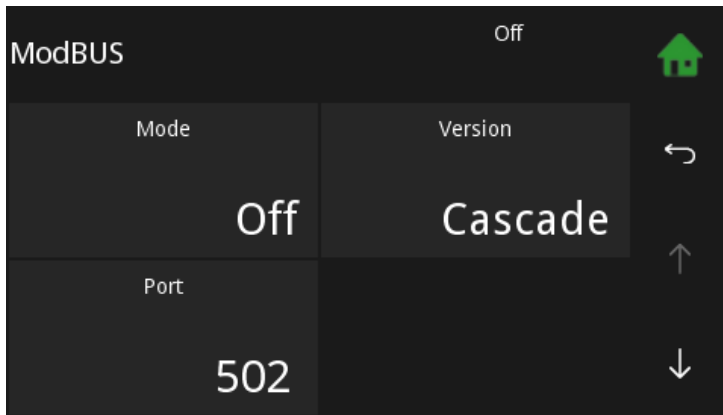

**Note:**

The Modbus registers may be set not less than two hours in cyclic operation, otherwise the life span of the operating device can decrease.

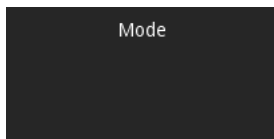

**Off**  
**TCP Server**

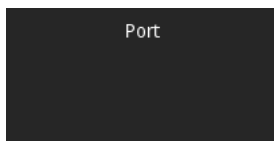

Defaultport for ModBUS is 502.

## 17.7 E-Mail

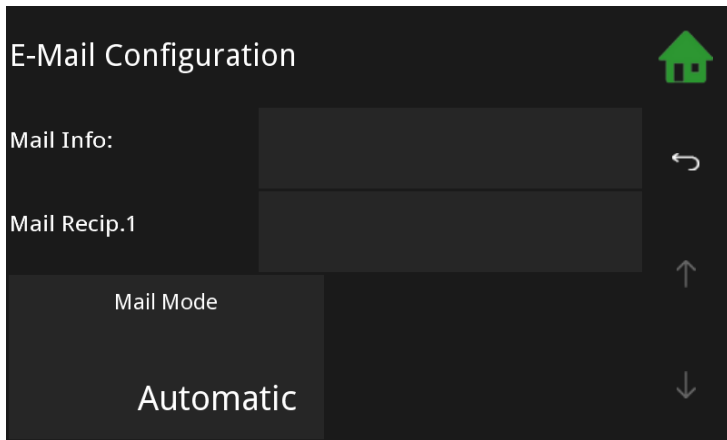

Delivery of disturbance-emails is done through an Maine Energy system server.

Only the recipient address needs to be configured.

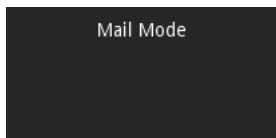

To ensure maximal flexibility, E-mail settings can set individually.

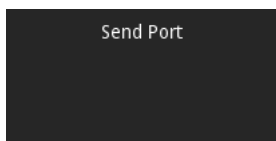

Port used for sending email (depends on provider).

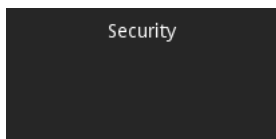

Select encryption mode (specified by provider).

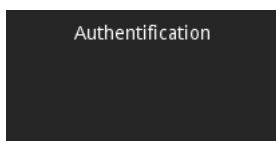

Authentication as specified by provider.

## 17.8 IP Config



**IP Config** is the menu General. (The menu item IP Config is only displayed if it has been activated by a qualified person)

*Network Configuration*  
↳ Not connected. 



IP:	10	.	1	.	1	.	1	↩
NM:	255	.	255	.	255	.	0	↑
GW:	1	.	0	.	0	.	0	
D1:	1	.	2	.	3	.	4	↓

After calling up the menu, a connection check is made.

If this is successful, "Connected to LAN and Internet" is displayed.

*Network Configuration*

↳ Not connected. 

IP:	10	.	1	.	1	.	1	
NM:	255	.	255	.	255	.	0	
GW:	1	.	0	.	0	.	0	
D1:	1	.	2	.	3	.	4	

Insert the **IP (Address)**, **NM (Netmask)** and **GW (Gateway)**, D1 (in most cases similar to GW) and **D2 (optional)**.

**IP:** IP address in the local network

**NM:** Networkmask is required in the local network.

**GW:** The gateway enables the touch operating device the access to the internet.

**D1, D2:** Server, which provide routing information



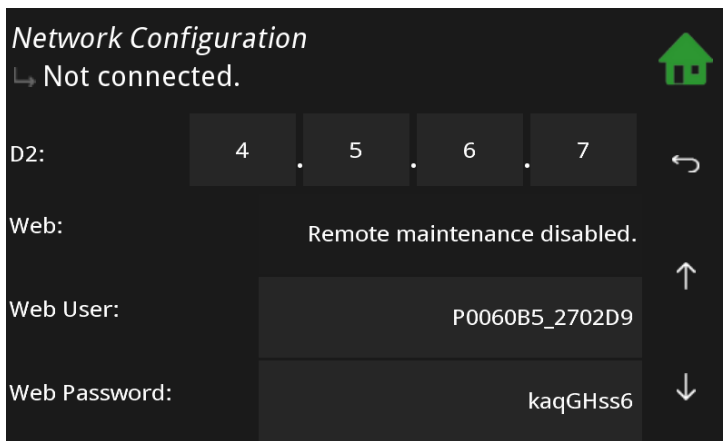

The screenshot shows a 'Network Configuration' screen with a green house icon in the top right corner. The status at the top left is 'Not connected.' with a green arrow pointing right. Below this are four input fields: 'D2:' with the value '4.5.6.7' and a right-pointing arrow; 'Web:' with the value 'Remote maintenance disabled.' and an up-pointing arrow; 'Web User:' with the value 'P0060B5\_2702D9' and an up-pointing arrow; and 'Web Password:' with the value 'kaqGHss6' and a down-pointing arrow.

Set **DHCP On** or **Off** depending on your network.

Enter the **Port** (Default **80**).

**Web:** IP address in local network

**Web User:** Networkmask is required in local network

**Web Password:** The gateway enables the touch operating device the access to the internet.

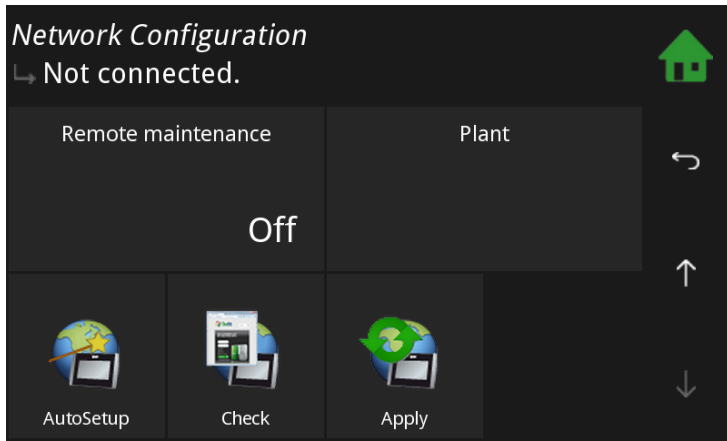

Activate optionally the **Ping** function.

## NOTICE

To prevent the modem from switching into standby mode, a ping command is executed every 10 minutes.

**You get the data from your network technician.**

### Configuration

This menu item is only active when a compatible USB wireless adapter is connected. (not every wireless stick works with the Touch operating device)  
By default, this item is hidden and located in LAN mode.  
If the wireless mode is enabled, a password box appears.

### DHCP

Dynamic address assignment on the local network (should be disabled if possible).

### WiFi

If a WLAN stick is recognized and supported, an Additional LAN & WLAN button appears.

### Password

Password of router.

### Port

0

Address extension with which the touch remote control is accessible.  
In principle, you can make your own choice, certain ports are associated with special services, e.g. 25 Mail, 80 Web and so on.

### Ping

The ping prevents the internet connection from being closed by the router.  
Therefore a query to the Maine Energy Systems server is started at certain time intervals.  
So the router detects that the connection is still active.

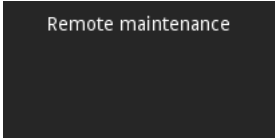
 Remote maintenance
**Automatic**

This will attempt to automatically set up the router using the UPNP protocol port forwarding. If this service is disabled on the router or doesn't work properly, it is canceled accompanied by an appropriate error message. As this function is time-consuming (may take a few minutes), it is running in the background. Whatever the UPNP If available, the Touch operating device registers on the Maine Energy Systems remote control server with it's current external IP Address. In case of change of address by the external provider, this is detected and sent to the server Maine Energy Systems.

**Manual**

In this mode, the port forwarding must be set manually. (for lack of UPNP) The port of the touch panel must correspond to the external shared port. The touch then registers with the external IP address and port on Ök-oFEN remote maintenance server. In case of change of address by the external provider, this is detected and sent to the Maine Energy Systems server.

**Static**

In this mode, no connection data is transferred to the Maine Energy Systems server and the online service of Maine Energy Systems can not be used. But the remote controll of the Touch operating device remains active and can be uses as before via port forwarding, DynDns, fixed external IP, LAN and so on.

**Remote maintenance access**

This function determines the network settings automatically. For this the DHCP mode is activated and the required settings are set automatically. Afterwards DHCP is deactivated. Because of this, the IP address of the contol unit can change.

The settings are set as follows:

- DHCP Off
- Ping On
- Port 8080
- Remote maintenance: Automatic



Back to the menu **General**.

# 18 Software



**Software** is in the Main menu.

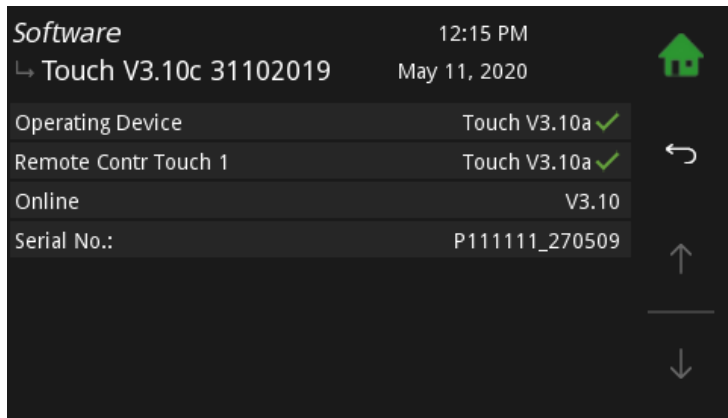

**Software** shows you the name of the current software.

# 19 Emptying the ash pan

## CAUTION

Risk of burns  
Do not touch the boiler vessel. Use gloves.

## DANGER

Risk of fire  
Bring out the ash pan immediatly.  
Do not dispose ash until it has completely cooled down.  
Empty ash only into a not flammable steel container.  
Do not use ash container to store waste or other material.  
Do not empty ash onto flammable floors or materials.

### Emptying the ash pan

**Note:**

Check the level of the ash pan and empty it at regularly intervals (at least every 2 weeks). No warning is displayed indicating that ash pan needs to be emptied when it is full (unlike external ash box)

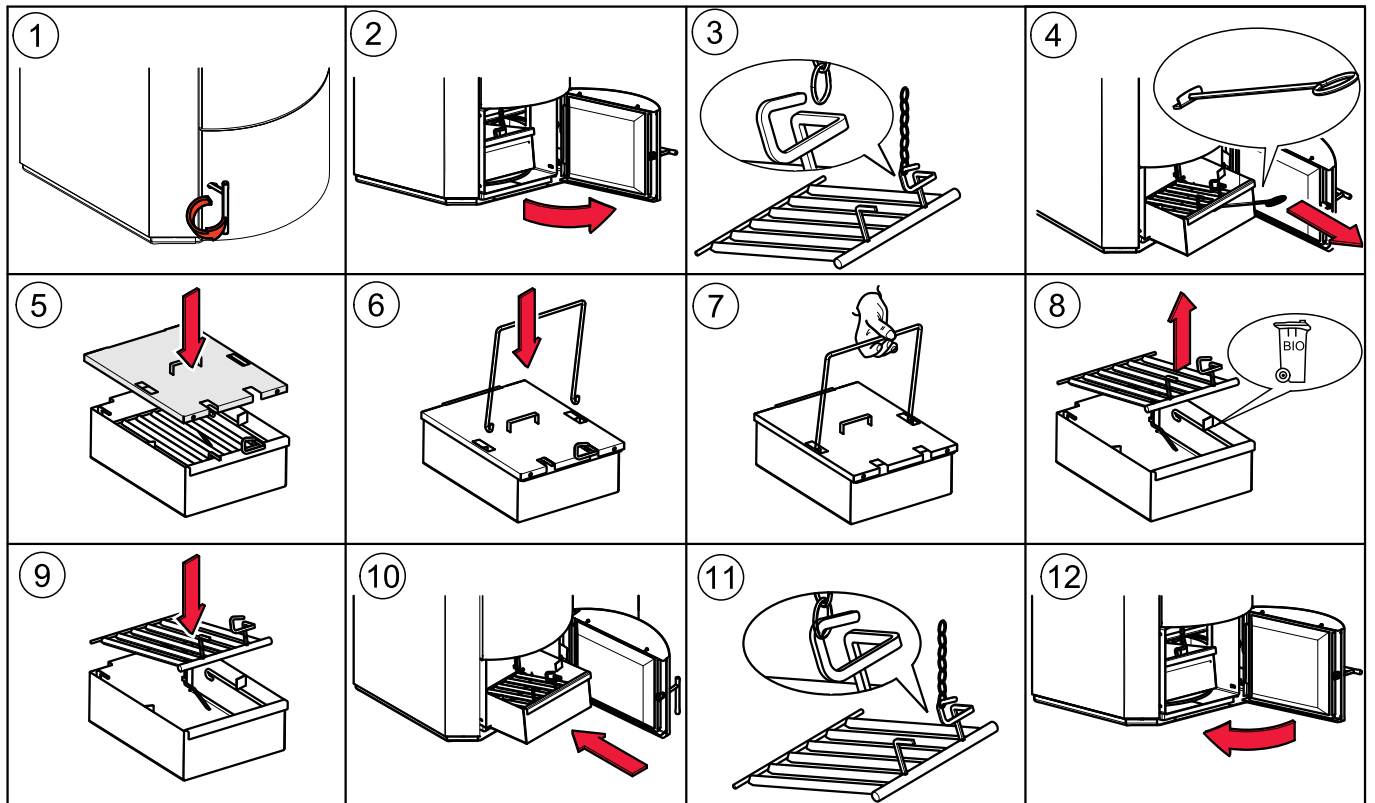
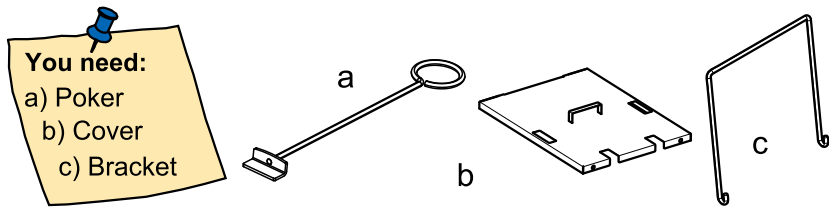

\* No riddle grate for systems with burner plate cleaning system.

## 20 Emptying the ash box

**Only on boilers with external ash box.** We also offer an optional automatic external ash box. This compresses the ash and reduces the frequency at which it needs to be emptied. It enables the ash to be disposed off without creating dust. Installation is performed by the service technician when the pellet boiler is installed. An external ash box can also be retrofitted.

### NOTICE

#### Damage to property

Empty the ash box before a longer off-time of the boiler. Otherwise the auger and the opening mechanism can be blocked through firmly bonded ash.



### DANGER

#### Risk of fire

Bring out the ash box immediately.  
Do not dispose ash until it has completely cooled down.  
Empty ash only into a not flammable steel container.  
Do not use the ash container to store waste or other material.  
Do not empty ash onto flammable floors or materials.

**Emptying the ash box**

**Note:**

When the ashbox is full then **Ash!!!** appears on the display with the alarm text **Ash box full**. After emptying and restarting the ash box the alarm text disappears automatically.

**You need:**  
 a) Ash container  
 b) Base

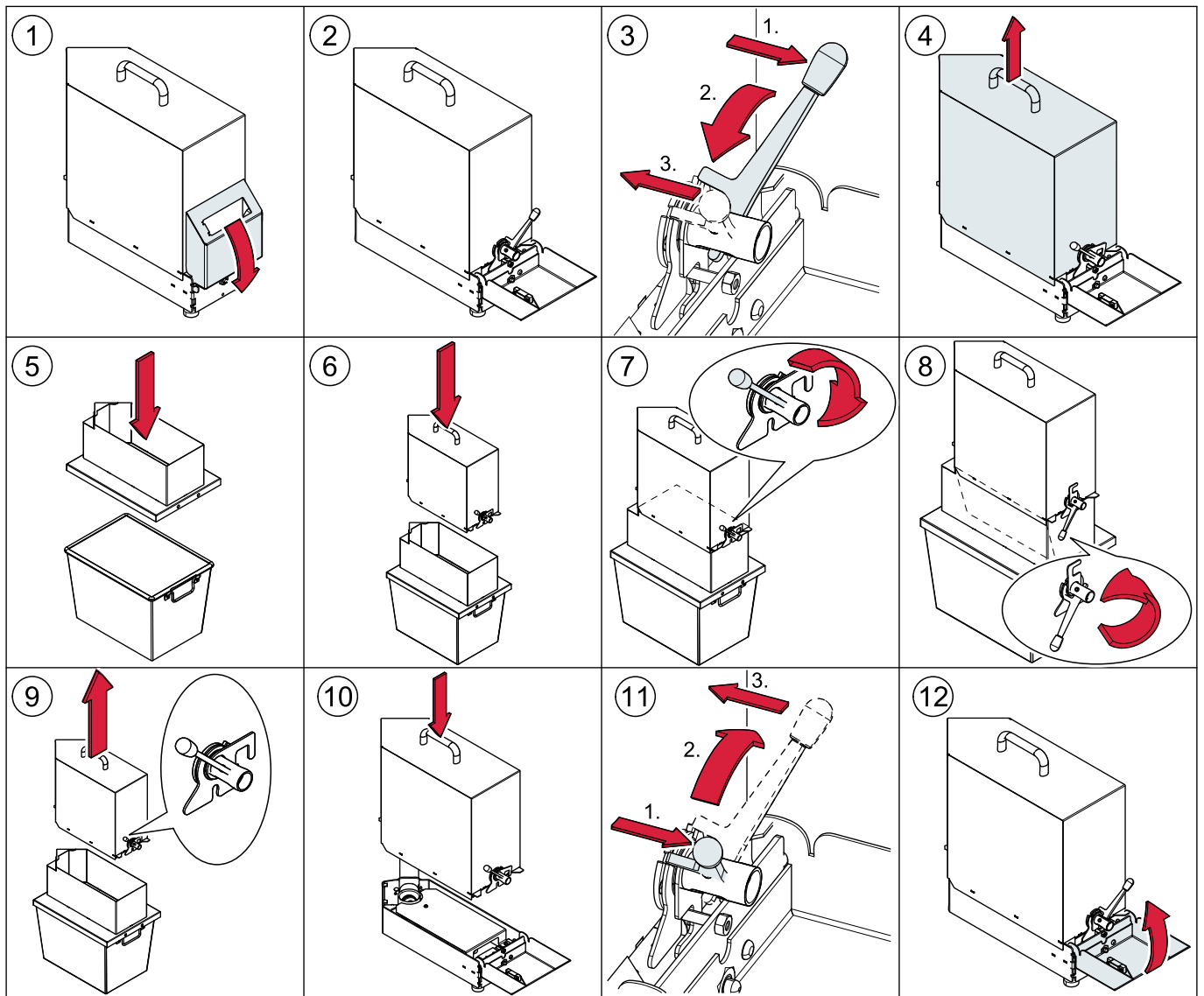
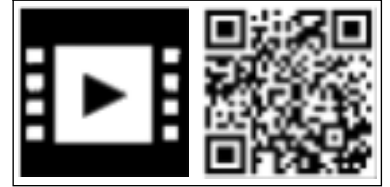
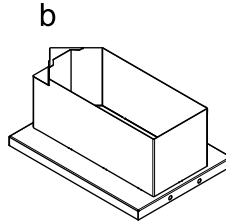
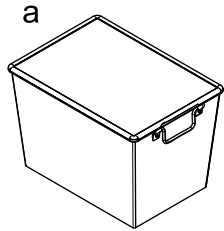

# 21 Maintenance and servicing

Regular checks of the pellet heating system are a prerequisite for reliable, efficient and environment-friendly operation.

## NOTICE

This wood heating appliance needs periodic inspection and repair for proper operation. It is against federal law to operate this wood heating appliance in a manner inconsistent with operating instructions in the manual.

## NOTICE

Ashes should be placed in a metal container with a tight-fitting lid. The closed container of ashes should be placed on a noncombustible floor or on the ground, well away from all combustible materials, pending final disposal. If the ashes are disposed of by burial in soil or otherwise locally dispersed, they should be retained in the closed container until all cinders have thoroughly cooled.

## 21.1 Maintenance

The maintenance, boiler cleaning and cleaning of flue gas connection it is necessary at least once a year. For PE(S) 36-56 it is necessary in any case at least every 2000 operating hours. Pellets which produces tendentially more slagging (ash melting point  $<2372$  °F) and pellets with higher bulk density ( $> 650$ kg) leads to additional cleaning of the burner plate at regular intervals.

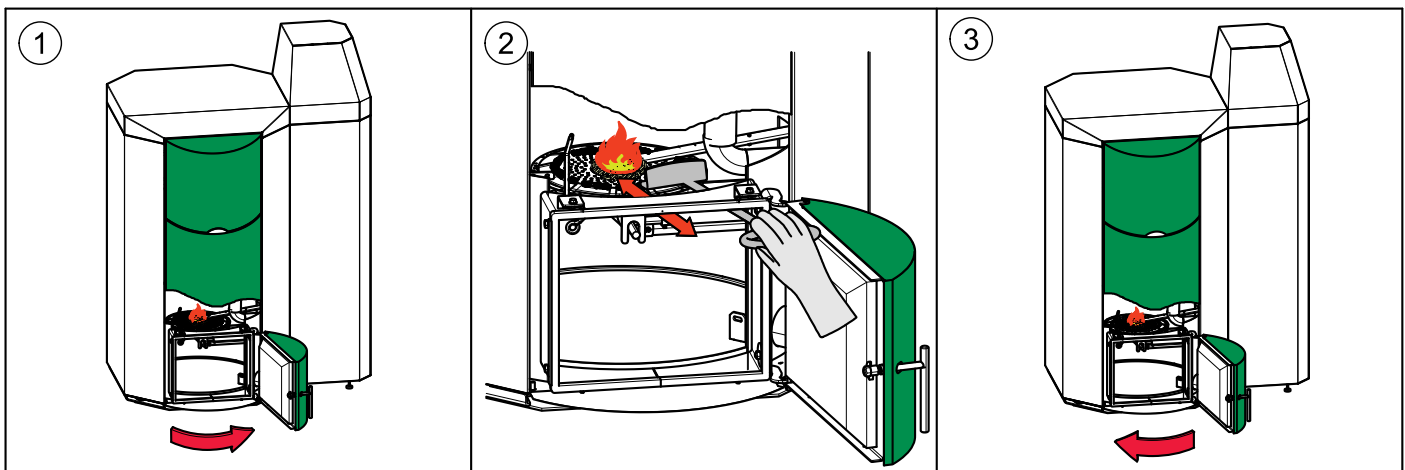



## 21.2 Cleaning the boiler every year

### NOTICE

The pellet boiler is equipped with an automatic cleaning system that cleans the heat exchanger every day. In addition, you need to clean the boiler manually once a year before the start of the heating season.

### NOTICE

Cleaning of the pellet boiler has to be performed from a authorized service technician at least every third year.



### WARNING

#### Risk of burns

Do not clean the boiler until it has been allowed to cool down.

Switch off the heating system at least 6 hours before opening the boiler.

Switch off the main switch before starting any maintenance work on the system.



### CAUTION

Risk of cut injuries due to sharp edges

Use gloves.

#### Note:

Check first of all, if all seals are in a good condition and the doors closes tightly.

## Procedure for cleaning the boiler

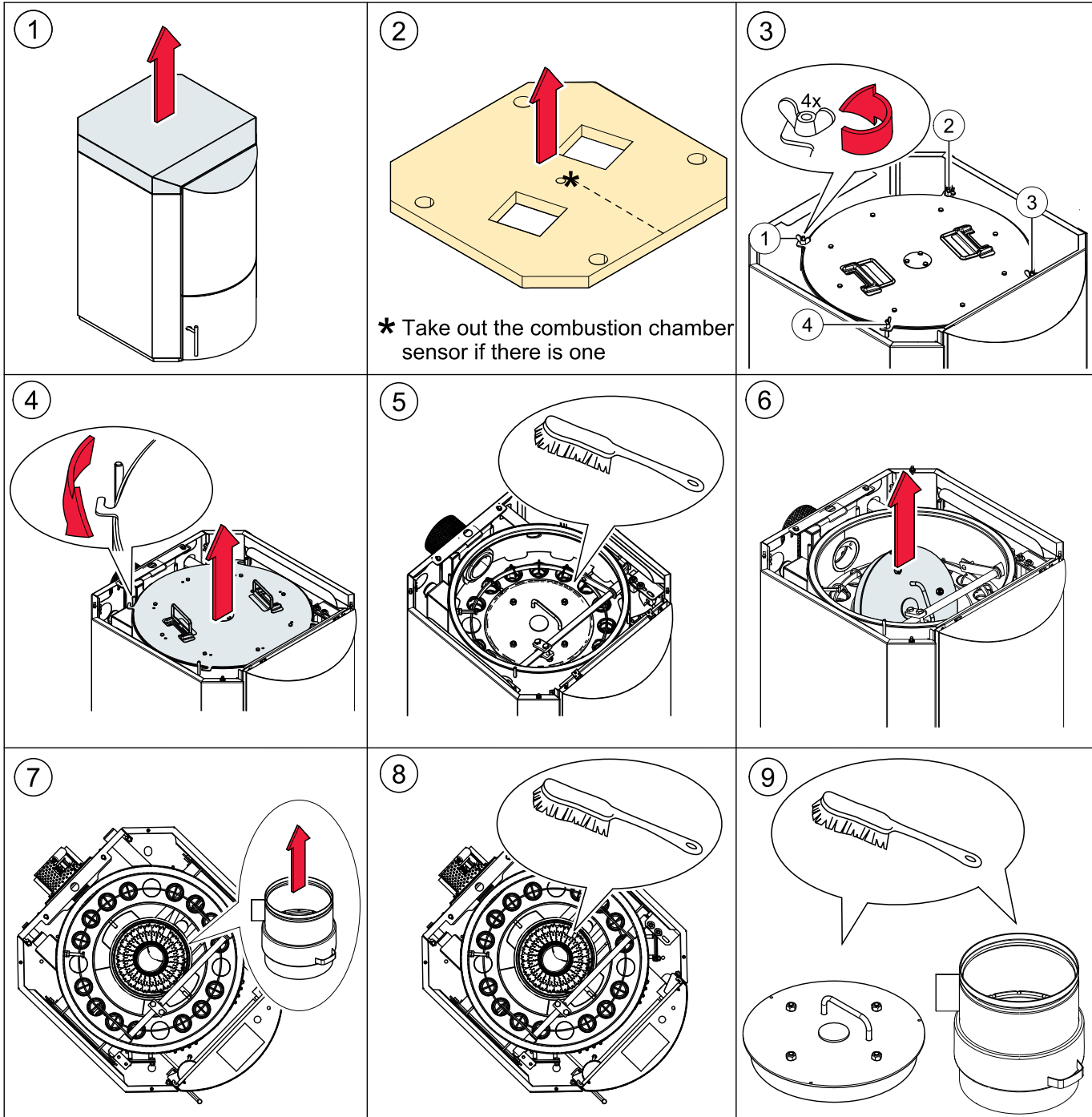
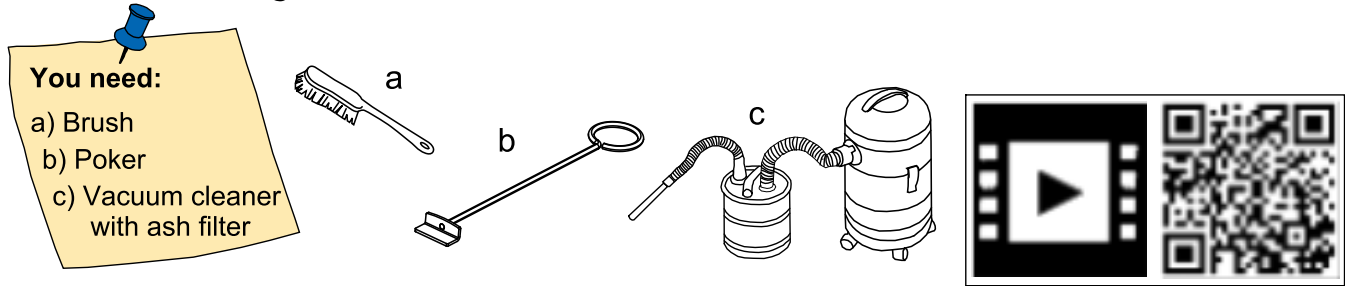

## NOTICE

Reduction in boiler performance and damage to pellet boiler due to blockages in the air inlet  
Clean the air intakes, the burner plate and the flame tube.

PE(S)(K)(B) 10- 32

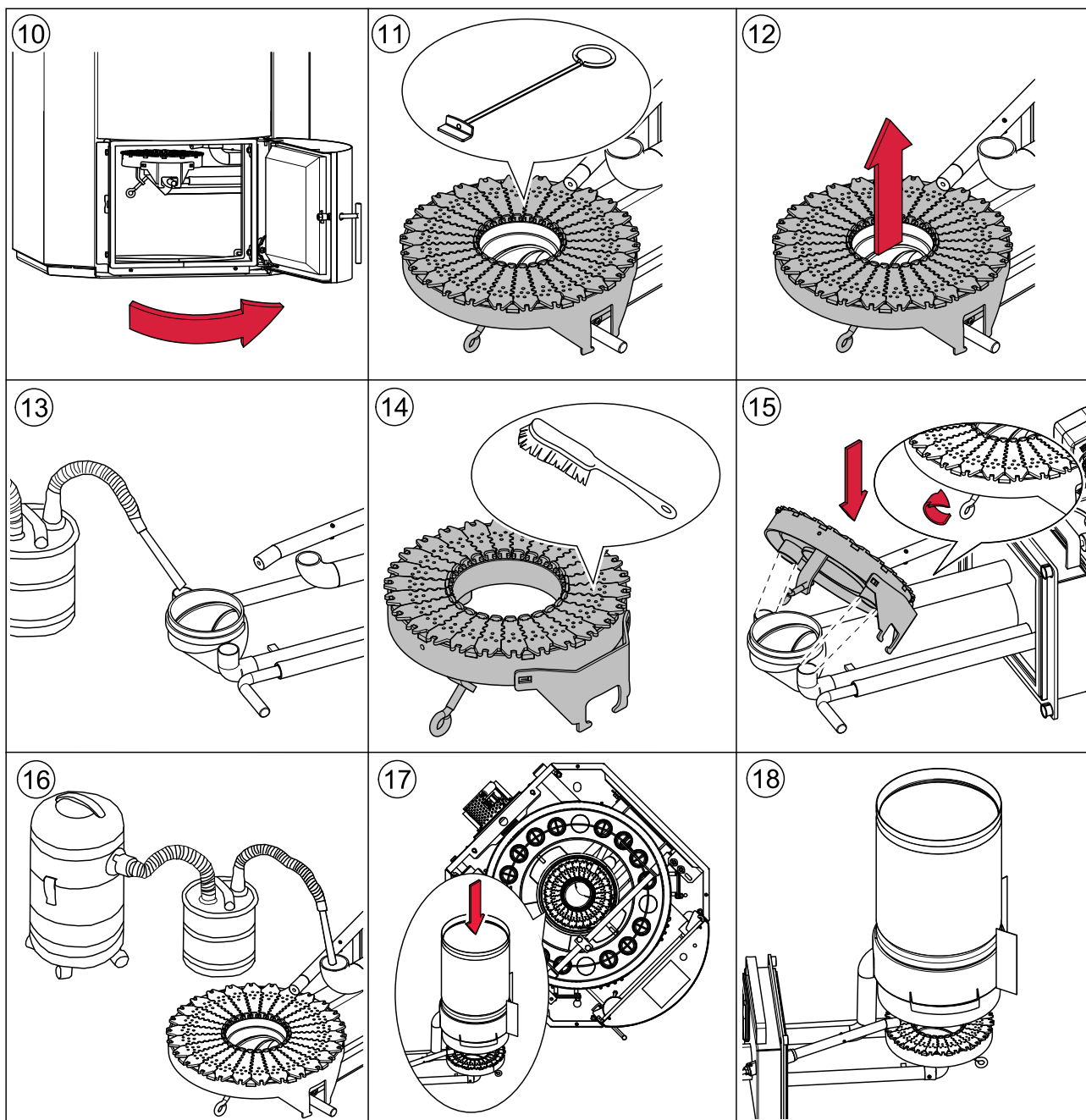

**Note:**

The individual parts of the multi segmented brazier may not be in raised position!

PE(S)(K)(B) 36 - 56

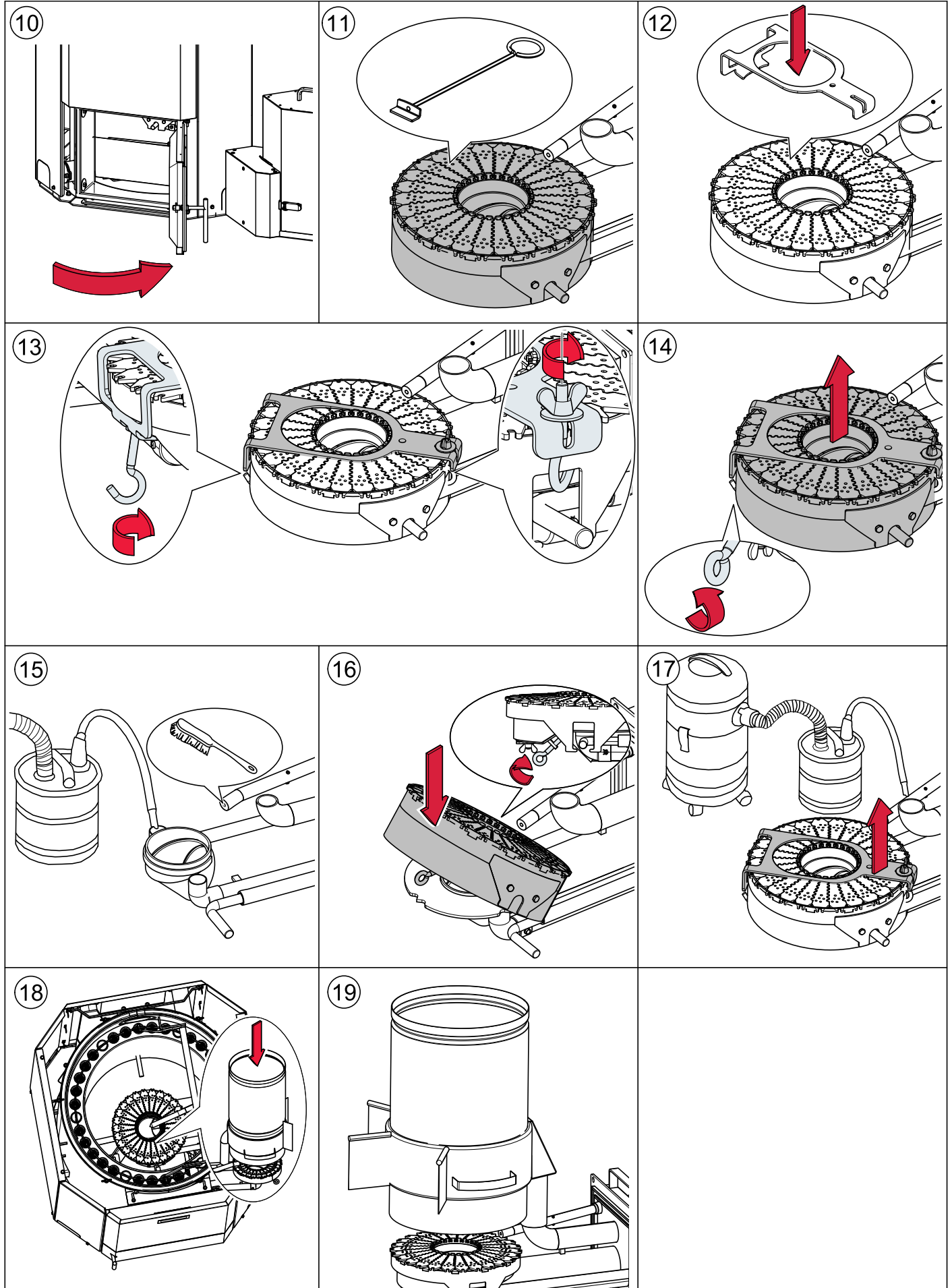

**Note:**

The individual parts of the multi segmented brazier may not be in raised position!

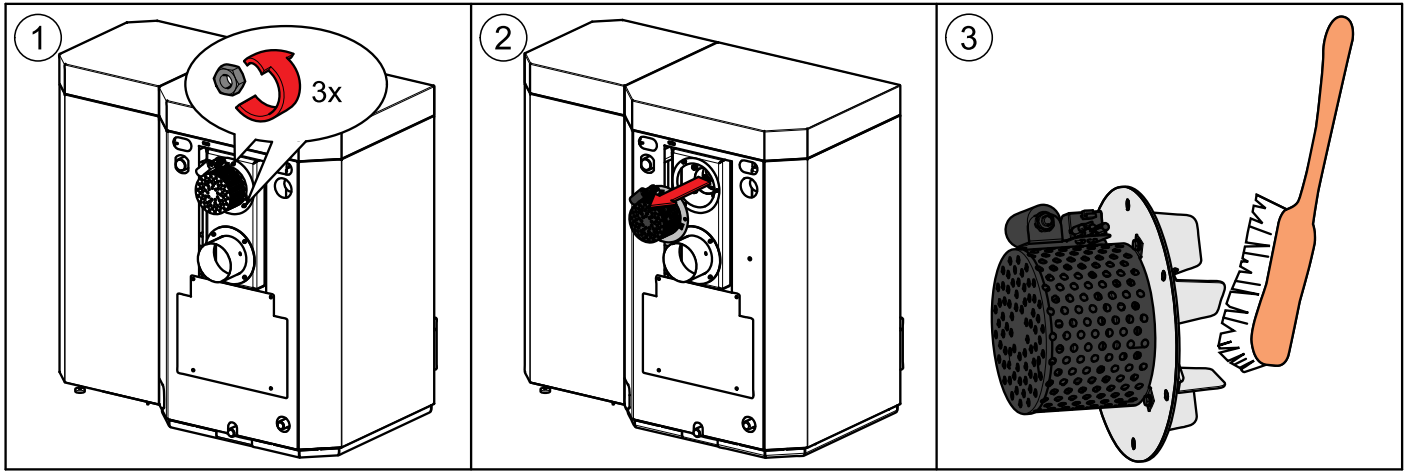
**Cleaning the Induced draft blower:**

## 21.3 Maintenance intervals

We recommend taking out a maintenance contract with your service technician.

## 21.4 Repairs



Only authorised specialists may carry out repair work on this system. Use original spare parts only. Not using original spare parts will cause the warranty to become void.

## 21.5 Checking the boiler room and storage room

Checking the pellet heating system regularly prevents malfunctions and unexpected failure of the heating system.

### Boiler room

Make sure that no flammable materials are stored in the boiler room.

Make sure that no washing is hanging in the boiler room.

Check the display on the control panel for malfunction messages.

Check the flue gas tube and chimney. Clean it regularly.

Maintenance clearances as given in Installation Manual must be observed at all times.

Do not store fuel or any other materials within these clearances.

### Storage room



## DANGER

### Risk of suffocation

Ventilate the pellet storage room sufficiently before entering.

Switch off the heating system before entering.

Check the level of pellets in the textile tank and order more pellets in good time.

## 22 Data for 20KW model, including emissions



### MESys

Maine Energy Systems, LLC  
8 Airport Road, Bethel, Maine 04217  
Voice: 207.824.6749 Fax: 207.824.4816

Report No. 0444PB004S

<b>Type:</b> Pellematic20	<b>S/N:</b> XUT xx	<b>CATALOG No.:</b> PES20
<b>Date of manuf.:</b> 02/2018	<b>Rated heat power:</b> 68,300BTU/hr	
<b>Tested to:</b> UL 2523-2013. CSA B366.1-2011 EN303-5		
<b>Manufactured By:</b> MESys LLC, Bethel, Maine		<b>FUEL:</b> WOOD PELLETS
U.S. ENVIRONMENTAL PROTECTION AGENCY certified to comply with the 2020 particulate emissions standard using wood pellets.		
This appliance needs periodic inspection and repair for proper operation. Consult owner's manual for further information. It is against federal regulations to operate this appliance in a manner inconsistent with operating instructions in the owners manual.		
<b>Particulate Emissions,</b> 0.028 lb./million btu - 0.227 grams/hr. <b>CO emissions,</b> 0.019 grams/min. <b>Annual Efficiency, (HHV)</b> 74.3%		
<b>Water Capacity:</b> 15.0 Gallons	<b>Operating Temp:</b> 194 °F	
<b>Max Operating Pressure:</b> 3 BAR / 43.5 PSI / 1204 inches WC		
<b>Chimney</b>	Approved factory built stainless steel or tile-lined masonry	
<b>MAX DRAFT:</b> 0.11 inches WC <b>MIN DRAFT:</b> 0.04 inches WC		
<b>Diameter:</b> 6 INCH	<b>Electrical Rating:</b> 220 V, 60 Hz, 14 A, 1760 W	
<b>FLOORING:</b> COMBUSTIBLE FLOORS CAN BE USED WITH A NON-COMBUSTIBLE SHIELD. MINIMUM CLEARANCES ARE 18IN/457MM IN THE FRONT AND 8IN / 203MM ON EACH SIDE.		
<b>PARTS</b>	<b>Fan Flue Gas:</b> E1001A	<b>Controller Display:</b> E1330
<b>Motor Ash Box:</b> E1302	<b>Motor Flame Return Protection:</b> E1413A	
<b>Motor Cleaning Device:</b> E1054	<b>Motor Hopper:</b> NA	
<b>Motor Burner Plate Cleaning:</b> NA	<b>Suction Turbine:</b> E1205	
<b>Motor Burner Screw:</b> E1030	<b>Low Water Cut Off:</b> Safgard 550SV	
<b>Controller Board:</b> E1412	<b>Pressure-Relief Valve:</b> Watts Co335M1	
<b>Motor Auger Screw:</b> FKAEM 150 / FKAE-S	<b>Fan Burner:</b> E1005S	

## 23 Data for 32KW model, including emissions



### MESys

Maine Energy Systems, LLC  
8 Airport Road, Bethel, Maine 04217  
Voice: 207.824.6749 Fax: 207.824.4816

Report No. 0444PB004S

<b>Type:</b> Pellematic32		<b>S/N:</b> XUT xx	<b>CATALOG No.:</b> PES32
<b>Date of manuf.:</b> 02/2018		<b>Rated heat power:</b> 109,000 BTU/hr	
<b>Tested to:</b> UL 2523-2013. CSA B366.1-2011 EN303-5			
<b>Manufactured By:</b> MESys LLC, Bethel, Maine		<b>FUEL:</b> WOOD PELLETS	
<b>U.S. ENVIRONMENTAL PROTECTION AGENCY</b> certified to comply with the 2020 particulate emissions standard using wood pellets.			
This appliance needs periodic inspection and repair for proper operation. Consult owner's manual for further information. It is against federal regulations to operate this appliance in a manner inconsistent with operating instructions in the owners manual.			
<b>Particulate Emissions,</b> 0.021 lb./million btu - 0.319 grams/hr. <b>CO emissions,</b> 0.025 grams/min. <b>Annual Efficiency,</b> (HHV) 76.5%			
<b>Water Capacity:</b> 23.6 Gallons		<b>Operating Temp:</b> 194 °F	
<b>Max Operating Pressure:</b> 3 BAR / 43.5 PSI / 1204 inches WC			
<b>Chimney</b>	Approved factory built stainless steel or tile-lined masonry		
<b>MAX DRAFT:</b> 0.11 inches WC <b>MIN DRAFT:</b> 0.04 inches WC			
<b>Diameter:</b> 6 INCH		<b>Electrical Rating:</b> 220 V, 60 Hz, 14 A, 1760 W	
<b>FLOORING:</b> COMBUSTIBLE FLOORS CAN BE USED WITH A NON-COMBUSTIBLE SHIELD. MINIMUM CLEARANCES ARE 18IN/457MM IN THE FRONT AND 8IN / 203MM ON EACH SIDE.			
<b>PARTS</b>	<b>Fan Flue Gas:</b> E1001A	<b>Controller Display:</b> E1330	
<b>Motor Ash Box:</b> E1302	<b>Motor Flame Return Protection:</b> E1413A		
<b>Motor Cleaning Device:</b> E1054		<b>Motor Hopper:</b> NA	
<b>Motor Burner Plate Cleaning:</b> NA		<b>Suction Turbine:</b> E1205	
<b>Motor Burner Screw:</b> E1030		<b>Low Water Cut Off:</b> Safgard 550SV	
<b>Controller Board:</b> E1412		<b>Pressure-Relief Valve:</b> Watts Co335M1	
<b>Motor Auger Screw:</b> FKAEM 150 / FKAE-S		<b>Fan Burner:</b> E1005S	



## 24 Data for 56KW model, including emissions



### MESys

Maine Energy Systems, LLC  
8 Airport Road, Bethel, Maine 04217  
Voice: 207.824.6749 Fax: 207.824.4816

Report No. 0444PB004S

<b>Type: Pellematic56</b>	
<b>S/N:</b> XUT01553	<b>CATALOG No.:</b> PES56
<b>Date of manuf.:</b> 09/2020	<b>Rated heat power:</b> 191,000 BTU/hr
<b>Tested to:</b> UL 2523-2013. CSA B366.1-2011 EN303-5	
<b>Manufactured By:</b> MESys LLC, Bethel, Maine	<b>FUEL:</b> WOOD PELLETS
<b>U.S. ENVIRONMENTAL PROTECTION AGENCY:</b> Certified to comply with the 2020 particulate emissions standard using wood pellets.	
This appliance needs periodic inspection and repair for proper operation. Consult owner's manual for further information. It is against federal regulations to operate this appliance in a manner inconsistent with operating instructions in the owners manual.	
Particulate emissions, 0.06lb./million btu - 0.952grams/hr. CO emissions, 0.052grams/minute. Annual efficiency (HHV) 81.9%	
<b>Water Capacity:</b> 30.6 Gallons	<b>Operating Temp:</b> 194 °F
<b>Operating Pressure:</b> 3 BAR / 43.5 PSI / 1204 inches WC	
<b>Chimney</b> Approved factory built stainless steel or tile-lined masonry	
<b>max DRAFT: 0.11 inches WC</b> <b>min DRAFT: 0.04 inches WC</b>	
<b>Diameter:</b> 7 INCH	
<b>Electrical Rating:</b> 220 V, 60 Hz, 14 Amp, 1760 Watts	
<b>FLOORING:</b> Combustible floors can be used with a non-combustible shield. Minimum clearances are 18in/457mm in the front and 8in/203mm on each side.	
<b>PARTS</b>	<b>Fan, Flue Gas:</b> E1249A
<b>Controller Display/Screen:</b> E1330	
<b>Motor Flame Return Protection:</b> E1413A	<b>Motor Ash Box:</b> E1302
<b>Motor Cleaning Device:</b> E1054	<b>Motor Hopper:</b> E1197
<b>Motor Burner Plate Cleaning:</b> E1204	<b>Suction Turbine:</b> E1205
<b>Motor Burner Screw:</b> E1306	<b>Low Water Cut Off:</b> Safgard 550SV
<b>Controller Board:</b> E1412	<b>Pressure-Relief Valve:</b> Watts Co335M1
<b>Fan Burner:</b> E1005S	<b>Motor Auger Screw:</b> FKAEM 150 /FKAE-S

## 25 General information

As require by the United States Department of Environmental Protection the following information is given for the:

AutoPellet Pellematic PES 10-56 wood pellet fired central heating boiler. Manufactured by Maine Energy Systems, of 8 Airport Road, Bethel, Maine, 04217

- The Pellematic has a thermal output levels from **3 kW** or **10,000** btu/h to 191,000 btu/h and complies with EPA 2020 requirements.
- This wood heater has a manufacturer-set minimum low burn rate that must not be altered. It is against federal regulations to alter this setting or otherwise operate this wood heater in a manner inconsistent with operating instructions in this manual.
- Complete installation information is found in the Installation Manual.
- Although operational information is elsewhere in this manual, there are specific concerns for correct operation that can directly affect the emissions profile of this equipment. It is therefore necessary that we mention these important points.
- Fuel loading and selection. Your Pellematic is equipped with completely automatic fuel loading. Thus, other than selecting the correct fuel, there are no loading instructions as such. Fuel selection is straight forward.  
Only PFI Premium 100% wood pellets should be used in your boiler.
- Among the materials that are specifically prohibited to be burned in your Pellematic are: trash, plastics, gasoline, rubber, naphtha, household garbage, material treated with petroleum products such as particleboard, railroad ties, and pressure treated wood.  
Burning these materials may result in release of toxic fumes or render the boiler ineffective and cause smoke.
- Your Pellematic pellet fired boiler is completely automatic ignition as well as the loading as before mentioned.  
There are therefore no starting procedures to be followed. The boiler correctly starts itself when required by building load.
- There are no user adjustments required for the air controls on your Pellematic.
- It is important to have your Pellematic boiler serviced by a trained professional who is aware of the importance to ensure that there are no inlet air restrictions in or around your boiler's combustion blower. And that the air passages within your boiler are free of debris, (creosote, ash, etc.)  
The flue pipe and chimney are also clean and free of debris / restrictions.  
And that the combustion chamber door seal is airtight when the door is closed and secured.
- Ash removal is also completely automatic on your Pellematic boiler. Ashes should be placed in a metal container with a tight-fitting lid.  
The closed container of ashes should be placed on a noncombustible floor or on the ground, away from all combustible materials, pending final disposal. The ashes should be retained in the closed container until all cinders have thoroughly cooled.  
When cooled ashes can be disposed of on your lawn, garden or local transfer station.
- Your Pellematic is not a catalytic type burner.
- A person or persons responsible for the operation of a hydronic heater must comply with all applicable laws or other requirements, such as State laws or regulations as well as local ordinances.
- A person or persons operating a hydronic heater should be aware that they are responsible for operation in such a manner that does not create a public or private nuisance condition.  
The Manufacturer's distance and stack height recommendations and the requirements in any applicable laws or other requirements may not always be adequate to prevent nuisance conditions due to terrain or other factors.
- Your Pellematic should be installed with a minimum stack height of 16 feet.  
Providing correct draft as given in the Installation manual.
- Draft is the force which moves air from the appliance up through the chimney.

The amount of draft in your chimney depends on the length of the chimney, local geography, nearby obstructions and other factors. Too much draft may cause excessive temperatures in the appliance and may damage the catalytic combustor. Inadequate draft may cause backpuffing into the room and 'plugging' of the chimney. Inadequate draft will cause the appliance to leak smoke into the room through appliance and chimney connector joints. An uncontrollable burn or excessive temperature indicates excessive draft.

- **The efficiency of your 20KW Pellematic boiler running at full power is >80%.**
- **The efficiency of your 32KW Pellematic boiler running at full power is >83%.**
- **The efficiency of your 56KW Pellematic boiler running at full power is >86%.**
- This is the result of a laboratory test and was measured using the HHV of the fuel used.
- You should never operate a combustion appliance of any type in your home without there being a properly installed smoke and CO detector.  
Your local fire department usually has good advice on placement of these detectors and how many your home may need for complete coverage.

## RESIDENTIAL LIMITED WARRANTY

**What this Warranty Covers & Who it Applies to:** The limited warranty provided by **Maine Energy Systems LLC** (“MESys”) applies only to MESys brand boilers, furnaces, wood pellet burners and accessories (“Product”) sold to you, the first user and purchaser provided that the Product was purchased: (1) for your normal, household (non-commercial) use, and has only been used for normal household purposes; (2) new at retail (not a display, “as is”, or previously returned model) and not for resale, or commercial use; and (3) within the United States. Products installed in a building other than a one or two family residential dwelling are not covered, under this Warranty unless individual Boilers are installed for each dwelling unit. Please return your registration card; while not necessary to establish warranty coverage, it allows MESys to be able to notify you in the unlikely event of a safety issue.

**How Long this Limited Warranty Lasts:** This Limited Warranty has three time frames, depending on the particular Product component involved.

(1) MESys warrants that the burner, ignition, electric and electronic parts, flame tube and burner plate, chains, bearings, chain pinions, and all other moving components of the Product are free from defects in materials and workmanship for a period of *two (2) years from the date of initial operation or 6,000 operating hours, whichever comes first*, provided they are installed and properly maintained by a qualified heating contractor and the other conditions of this warranty are met, and

(2) *In addition*, all other parts including the boiler vessel, or heat exchanger in furnaces, are warranted to be free from defects in materials and workmanship for a period of *five (5) years from the date of initial operation or 15,000 operating hours, whichever comes first* provided it is installed and properly maintained by a qualified heating contractor and the other conditions of this warranty are met; and

(3) *In addition* thereafter, MESys warrants that the boiler vessel is free from defects in materials and workmanship on a prorated basis follows, provided it is installed and properly maintained by a qualified heating contractor and the other conditions of this warranty are met:

*For the next five (5) years (years 6 through 10) or a maximum of 30,000 operating hours, whichever comes first*, the boiler vessel is warranted for 75% of the then retail parts cost; and thereafter

*For the next ten (10) years (years 11 through 20) or a maximum of 60,000 operating hours, whichever comes first*, the boiler vessel is warranted for 50% of the then retail parts cost.

*For the next ten (10) years (years 21 through 30) or a maximum of 90,000 operating hours, whichever comes first*, the boiler vessel is warranted for 25% of the then retail parts cost, which may be used to replace the boiler vessel, or used as a credit toward a new boiler system, at MESys’ discretion.

Labor is not covered under this limited warranty. During the pro-rated warranty period, the customer is responsible for payment of the remaining portion of the then retail cost.

The warranty period begins to run upon the date of initial operation, and shall not be extended for any reason whatsoever. This limited warranty does not cover labor and shipping costs, non-MESYS components, serviceable items or normal maintenance, nor the other items and events excluded below.

**Terms of Limited Warranty:** MESys will provide replacement parts for any component that proves to be defective in materials or workmanship (excludes labor charges) within the periods set forth above, or replace it with the most comparable model available from MESys at the time of the replacement, provided that the purchaser pays for the other portion of the prorated charge set forth above if applicable. The proportionate charge is based on the current list price of the boiler vessel involved in the warranty claim (or the nearest comparable MESys model). The foregoing timelines begin to run upon the date of initial operation, and shall not be stalled, tolled, extended, or suspended, for any reason whatsoever.

**Repair/Replace as Your Exclusive Remedy:** During this limited warranty period, MESys or one of its authorized service providers will provide replacement parts for your Product or replace it with the most comparable model then available from MESys at the time of the replacement (subject to certain limitations stated herein,) if your Product proves to have been manufactured with a defect in materials or workmanship. All removed parts and components shall become the property of MESys at its sole option. All replaced and/or repaired parts shall assume the status of the original part for purposes of this

warranty and this warranty shall not be extended by the replacement of such parts. MESys's sole obligation hereunder is to provide replacements for defective Product to a MESys-authorized service provider during normal business hours. For safety and property damage concerns, MESys highly recommends that you do not attempt to repair the Product yourself, or use an un-authorized servicer; MESys will have no responsibility or liability for repairs or work performed by a non-authorized servicer. If you choose to have someone other than an authorized service provider work on your Product, THIS WARRANTY WILL AUTOMATICALLY BECOME NULL AND VOID. Authorized service providers are those persons or companies that have been specially trained for customer service and technical ability (note that they are independent entities and are *not* agents, partners, affiliates or representatives of MESys).

**Warranty Exclusions:** The warranty coverage described herein excludes all defects or damage that are not the direct fault of MESys, including without limitation, any one or more of the following: (a) use of the Product in anything other than its normal, customary and intended manner (including without limitation, any form of commercial use or use that is not for personal, family or household purposes); (b) any party's willful misconduct, negligence, misuse, abuse, accidents, improper operation, failure to maintain, improper or negligent installation, tampering, failure to follow operating instructions, mishandling, unauthorized service (including self-performed "fixing" or exploration of the appliance's internal workings); (c) adjustment, alteration or modification of any kind; (d) a failure to comply with applicable state, local, city, or county electrical, plumbing and/or building codes, regulations and laws, including failure to install the product in strict conformity with local fire and building codes and regulations; (e) ordinary wear and tear; (f) any external, elemental and/or environmental forces and factors, including without limitation, lightning strikes, voltage spikes, flues that do not meet specified standards, fire, floods, rain, windstorm, floods, fires, mud slides, freezing, excessive moisture or extended exposure to humidity, power surges, building structural failures and acts of God; (g) any damage or failure resulting from contaminated air, including but not limited to sheetrock particles or other dirt or dust, introduced into the Boiler; (h) damage or failure resulting from hard water scale build-up on the heat exchanger waterways; (i) use with insufficient water or operation with water or fuel additives that cause deposits or corrosion; and (j) use with oxygen permeable tubing or other components. In no event shall MESys have any liability or responsibility whatsoever for damage to surrounding property and other structures or objects around the Product. Also excluded from this warranty are scratches, nicks, minor dents, and cosmetic damages on external surfaces and exposed parts; Products on which the serial numbers have been altered, defaced, or removed; service visits to teach you how to use the Product, or visits where there is nothing wrong with the Product; correction of installation problems (you are solely responsible for any structure and setting for the Product, including all chimneys, flues, electrical, plumbing or other connecting facilities, for proper foundation/flooring, and for any alterations); and resetting of breakers or fuses.

**TO THE EXTENT ALLOWED BY LAW, THIS WARRANTY SETS OUT YOUR EXCLUSIVE REMEDIES WITH RESPECT TO PRODUCT, WHETHER THE CLAIM ARISES IN CONTRACT OR TORT (INCLUDING STRICT LIABILITY, OR NEGLIGENCE) OR OTHERWISE. THIS WARRANTY IS IN LIEU OF ALL OTHER WARRANTIES, WHETHER EXPRESS OR IMPLIED. ANY WARRANTY IMPLIED BY LAW, WHETHER FOR MERCHANTABILITY OR FITNESS FOR A PARTICULAR PURPOSE, OR OTHERWISE, SHALL BE EFFECTIVE ONLY FOR THE PERIOD THAT THIS EXPRESS LIMITED WARRANTY IS EFFECTIVE OR THE IMPLIED WARRANTY PERIOD, WHICHEVER IS LESS. IN NO EVENT WILL MESYS BE LIABLE FOR CONSEQUENTIAL, SPECIAL, INCIDENTAL, INDIRECT, "BUSINESS LOSS", AND/OR PUNITIVE DAMAGES, LOSSES, OR EXPENSES, INCLUDING WITHOUT LIMITATION TIME AWAY FROM WORK, HOTELS AND/OR RESTAURANT MEALS, EXPENSES IN EXCESS OF DIRECT DAMAGES DEFINITELY CAUSED EXCLUSIVELY BY MESYS, OR OTHERWISE ARISING. SOME STATES DO NOT ALLOW THE EXCLUSION OR LIMITATION OF INCIDENTAL OR CONSEQUENTIAL DAMAGES, AND SOME STATES DO NOT ALLOW LIMITATIONS ON HOW LONG AN IMPLIED WARRANTY LASTS, SO THE ABOVE LIMITATIONS MAY NOT APPLY TO YOU. THIS WARRANTY GIVES YOU SPECIFIC LEGAL RIGHTS, AND YOU MAY ALSO HAVE OTHER RIGHTS, WHICH VARY FROM STATE TO STATE.**

The customer is responsible for the costs of:

- Components which have been replaced but found not to have been defective;
- Faulty installation;
- Normal maintenance; and
- Equipment used contrary to the installation manual.

The required information that must be furnished to MESYS for a claim under this Limited Warranty includes:

- Model number and serial number of the Product;
- Date the Product was installed and placed in operation, the location , the name of the installer;
- Date the Product component failure was reported; and

- Description of condition that prompted the report.

No attempt to alter, modify or amend this warranty shall be effective unless authorized in writing by an officer of MESYS.

**To Obtain Warranty Service, Please Contact**

**Maine Energy Systems, LLC ("MESys")**

8 Airport Road, P.O. Box 547, Bethel, Maine 04217

Tel: 207.824. 6749 Fax: 207.824.4816

[info@maineenergysystems.com](mailto:info@maineenergysystems.com)

Limited Warranty Boiler Resid 1-31-2013 REV  
6/13/2013 3:46 PM







## Author & Manufacturer

MAINE ENERGY SYSTEMS LLC  
8 Airport Road – P.O. Box 547 Bethel  
Maine 04217

E-Mail: [info@maineenergysystems.com](mailto:info@maineenergysystems.com)  
[www.maineenergysystems.com](http://www.maineenergysystems.com)

© MAINE ENERGY SYSTEMS LLC  
Subject to modifications