

Please read carefully prior
to installing and servicing.

SAVE THESE INSTRUCTIONS

Operating Manual

**Pellet heating with auger
delivery or vacuum suction
system for the end-user
AutoPellet Air Furnace
28**

MESys V1.1

AutoPellet Air TOUCH

USA

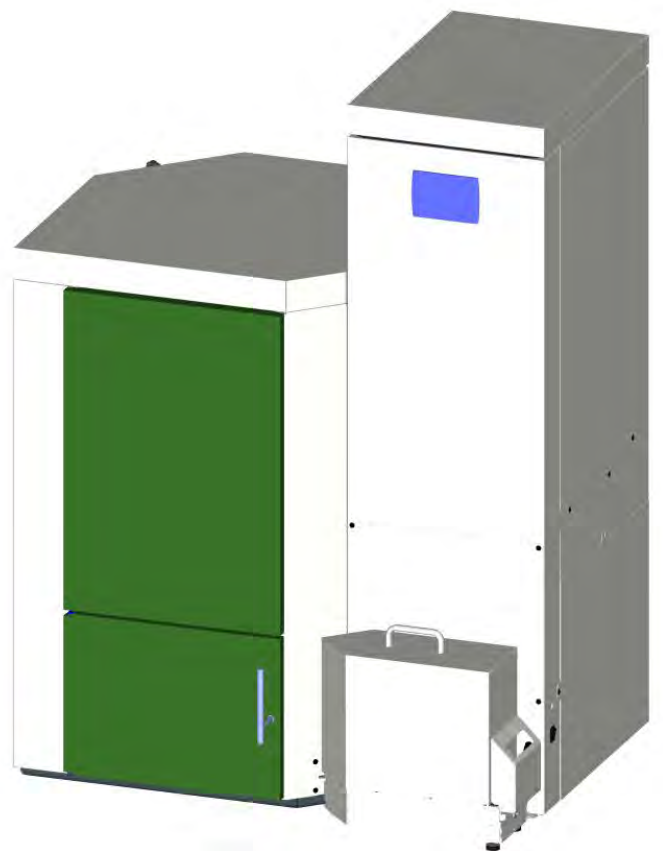

Title: Operating Manual AutoPellet Air Furnace 28 PE

Article number: 604 USA_FA 1.0

Version valid
from: **02/2025**

Approved: **MESYS**

Author & Manufacturer

MAINE ENERGY SYSTEMS LLC
8 Airport Road — P.O. Box 547 Bethel
Maine 04217

E-Mail: info@maineenergysystems.com
www.maineenergysystems.com

© MAINE ENERGY SYSTEMS LLC
Subject to modifications

Pour la version française de ce manuel, veuillez visiter notre site Web à
Maineenergysystems.com.

1. Dear Customer	5
1.1 Special Statement.....	5
2 Use only for the purpose intended	6
3 Types of safety warning sign	7
4 Warnings and safety instructions	8
4.1 Basic safety instructions	8
4.2 Warning signs.....	8
4.3 What to do in an emergency.....	10
5 Prerequisites for installing a pellet Furnace	11
5.1 Guidelines and standards for installing a pellet Furnace	11
5.2 Furnace room circulating air	11
5.3 Furnace room supply air	12
5.4 Flue gas system.....	13
5.5 Safety systems	15
5.6 Installation with an existing Furnace.....	15
6 Fuel	16
6.1 Specification for high quality pellets as PFI (Pellet Fuel Institut)	16
6.2 Storing the pellets	17
6.3 Measures for the ventilation of storage rooms.....	17
7 The pellet Furnace	18
7.1 Pellet suction system.....	20
7.1.1 Assembly of the vacuum system.....	20
7.2 Storage systems.....	22
7.2.1 Flexilo textile tank	22
8 Operating the Furnace	23
8.1 Operating the heating system	23
8.2 Description of the control panel	24
8.3 Setting language, date and time at Pelletronic Touch.....	25
8.4 Emptying the ash pan	27
8.5 Emptying the ash box	28
9 Operating Device with Touch screen	30
9.1 Opening window.....	30
9.2 User controls and their function.....	31
9.3 Main Menu	33
10 Mode	34
11 Measuring Values	35
12 Weather	36
13 Eco Mode	37
14 Heating Circuit	38
14.1 Measuring values Heating circuit.....	39
14.2 Time programme Heating circuit.....	40
14.3 Party.....	41
14.4 Vacation.....	41
14.5 Heating curve and Heating limits.....	42
15 Furnace	45
15.1 Measuring values.....	45
15.2 Locktime.....	46
15.3 Continuous running.....	46
15.4 Full Power	47
15.5 Fan.....	47
15.6 Suction turbine.....	49

16	General.....	50
16.2	Favorite	51
16.3	Local Settings.....	52
16.4	Malfunction	53
16.5	Information.....	53
16.6	ModBUS	54
16.7	E-Mail.....	55
16.8	IP Config.....	56
17	Software	59
18	Maintenance and servicing.....	60
18.1	Cleaning the Furnace every year	60
18.2	Maintenance intervals	63
18.3	Repairs	63
18.4	Checking the Furnace room and storage room	63

Note that warranty and replacement part information is included at the end of this manual. For warranty questions, refresher training, or replacement part inquiries (for all replacement parts including those pertaining to emissions control such as gaskets or other), please send an email to info@maineenergysystems.com including the system's address in the subject line. MESys provides replacement parts for installation by certified technicians.

1 Dear Customer

Maine Energy Systems specializes in wood pellet heating, our company enjoys an exclusive license from ÖkoFEN to manufacture AutoPellet Air here in the USA. We represent expertise, innovation and quality. We are delighted that you have decided to purchase our product.

- This instruction manual is intended to help you operate the product safely, properly and economically.
- Please read this instruction manual completely and take note of the safety warnings.
- Keep all documentation supplied with this unit in a safe place for future reference.
Please pass on the documentation to the new user if you decide to part with the unit at a later date.
- Installation and first start up must be carried out by an installer certified by Maine Energy Systems.
- Please contact your authorised dealer if you have any questions.



We place great importance on the development of new products. Our R&D department continues to question accepted solutions and works continually on new improvements. That is how we maintain our technological lead. We have already received several awards for our products in Austria and abroad. Our products fulfill European and USA requirements regarding quality, efficiency and emissions.



1.1 Special Statement

This unit is designed and tested to shut off at 30% of the tested maximum Category 4 tested heat rate as required by both Wood Heater Rule at 40 CFR §60.5476(e) and the Alternative Test Method (ATM)-134. No combustion settings are to be modified.

This wood heater needs periodic inspection and repair for proper operation. It is against federal regulations to operate this wood heater in a manner inconsistent with operating instructions in this manual.

This heating appliance is US EPA 2020 NSPS Compliant.

2 Use only for the purpose intended

The pellet furnace is designed heat air to provide heat for buildings. It is not permissible to use the furnace for any other purpose.

The pellet furnace fulfills the requirements of UL 391-2010 and CSA B366.1–2011.

This boiler is intended to be fueled by Pellet Fuels Institute (PFI) Certified Wood Pellets.

3 Types of safety warning sign

The warning signs use the following symbols and text.

Types of safety warning sign

1. Risk of injury
2. Consequences of risk
3. Avoiding risk



1. Risk of injury:

Danger - indicates a situation that could lead to death or life-threatening injury.



Warning - indicates a situation that could lead life-threatening or serious injury.



Caution - indicates a situation that could lead to injury.



Note - indicates a situation that could lead to property damage.



2. Consequences of risk

Effects and consequences resulting from incorrect operation.

3. Avoiding risk

Observing safety instructions ensures that the heating system is operated safely.

4 Warnings and safety instructions

Observing safety instructions ensures that the heating system is operated safely.

4.1 Basic safety instructions

- Never get yourself into danger; give your own safety the utmost priority.
- Keep children away from the Furnace room and storage room.
- Observe all safety warnings on the Furnace and in this user manual.
- Observe all instructions relating to maintenance, servicing and cleaning.
- Never make any changes to the heating system or flue gas system.
- Never close or remove safety valves.

4.2 Warning signs



DANGER

Risk of poisoning

Make sure that the pellet Furnace is supplied with sufficient combustion air.

The openings in the combustion air inlet must never be partially or completely closed.

Ventilation systems, central vacuum cleaning systems, extractor fans, air conditioning systems, flue gas blowers, dryers, fuel storage ventilation fans or similar equipment must never be allowed to draw air from the Furnace room and cause a drop in pressure.

The Furnace must be connected tight to the chimney using a flue gas tube.

Clean the chimney and the flue gas tube at regular intervals.

The Furnace room and pellet storage room must be sufficiently supplied with air and ventilated.

Before entering the storage room it must be ventilated with sufficient air and the heating system switched off



DANGER

Risk of electric shock

Always disconnect / de-energize the power supply before working on the Furnace.



DANGER

Risk of explosion

DO NOT BURN GARBAGE, GASOLINE, NAPHTHA, ENGINE OIL, OR OTHER INAPPROPRIATE MATERIALS. DO NOT USE CHEMICALS OR FLUIDS TO START THE FIRE.

Switch off the heating system before filling the storage room.



DANGER

Risk of fire

Do not store any flammable materials in the Furnace room.
Do not hang out any washing in the Furnace room.
Do not operate with fuel loading or ash removal doors open.



WARNING

Risk of burns

Do not touch the flue gas connector or flue gas pipe.
Do not reach into the ash chamber.
Use gloves to empty ash box if Furnace not equipped with automatic ash compression
Do not clean the Furnace until it has been allowed to cool down.



CAUTION

HOT SURFACES

Keep children away.
Do not touch during operation.
Do not operate if maximum draft as listed on Furnace nameplate is exceeded.
Doing so can allow non-controlled combustion.



CAUTION

Risk of cut injuries due to sharp edges.
Use gloves for performing all work on the Furnace.

NOTICE

Damage to property

The pellet Furnace is suitable only for pellets which comply with PFI premium or EnPlus -A1 pellets specifications. The use of any other fuel voids your warranty and can cause damage to the pellet Furnace and chimney.

NOTICE

Damage to property

Do not use the heating system if it, or any of its components, come into contact with water.
If water damage occurs, check the heating system and replace damaged parts.



WARNING

All cover plates, enclosures, and guards must be maintained in place at all times, except during maintenance and servicing.

4.3 What to do in an emergency



DANGER

Risk to life

Never get yourself into danger; give your own safety the utmost priority.

What to do in the event of a fire

- Switch off the heating system.
- Call your local fire department and or 911.
- Use approved fire extinguishers (fire protection class ABC).

What to do if you smell smoke

- Switch off the heating system.
- Close the doors leading to living areas.
- Ventilate the central heating room.

Important: Federal, State/Provincial, and Local Regulations, Laws, and Codes must be followed; use of smoke detectors and carbon monoxide monitors are recommended in accordance with applicable statutes.

INSTALL CO SMOKE DETECTORS IN THE LIVING AREA AND BEDROOMS OF YOUR HOME. TEST THEM REGULARLY AND INSTALL FRESH BATTERIES TWICE ANNUALLY.

WHEN INSTALLED IN THE SAME ROOM AS THE STOVE, A SMOKE OR CARBON MONOXIDE DETECTOR SHOULD BE LOCATED AS FAR FROM THE STOVE AS POSSIBLE TO PREVENT THE ALARM SOUNDING WHEN ADDING FUEL.

5 Prerequisites for installing a pellet Furnace

You must fulfil the following conditions before operating a fully automatic pellet Furnace.

5.1 Guidelines and standards for installing a pellet Furnace

Overview of standards and guidelines applying to the installation of a pellet Furnace.

Check whether you need to obtain planning permission or approval from the authorities for installing a new heating system or changing your existing system. Installation must meet all requirements for pellet fired heating systems in your specific location.

All equipment shall be installed in accordance with the instructions of the manufacturer and in a manner acceptable to the authority having jurisdiction by experienced personnel. When required by the authority having jurisdiction, such personnel shall be licensed to perform this service.

In Canada, the installation of the solid fuel furnace shall comply with the applicable requirements of CSA B365, and if changes are made to the installation of the oil furnace, these shall comply with CSA B139.

If changes are made to an electric furnace during the installation, the changes shall comply with the Canadian Electric Code. Part 1.

5.2 Furnace room circulating air

The pellet Furnace is installed in the Furnace room.

1. Safety instructions for the Furnace room

	DANGER
Risk of fire Do not store flammable materials or liquids in the vicinity of the pellet Furnace. Do not permit unauthorised persons to enter the Furnace room - Keep children away. Do not operate with fuel loading or ash removal doors open.	

2. Air supply and ventilation of Furnace room

The Furnace room must be fitted with air supply and ventilation openings (at least 31 inch²/200cm²). In any case you must comply with the state and local regulations

3. Damage due to frost and humid air

The Furnace room must be frost-proof to ensure trouble-free operation of the heating system. The temperature of the Furnace room must not fall below 37°F and must not exceed 90°F. The air humidity in the Furnace room must not exceed 70%.

4. Danger for animals

Make sure that household pets and other small animals cannot enter the Furnace room. Fit mesh over any openings.

5. Flooding

If there is a risk of flooding, switch off the pellet Furnace and disconnect from the power supply before water enters the Furnace room. You must have all components that come into contact with water replaced, before you start up the pellet Furnace again.

5.3 Furnace room supply air

The pellet Furnace is installed in the Furnace room.

1. Safety instructions for the Furnace room

	DANGER
Risk of fire Do not store flammable materials or liquids in the vicinity of the pellet Furnace. Do not permit unauthorised persons to enter the Furnace room - Keep children away. Do not operate with fuel loading or ash removal doors open.	

2. Air supply and ventilation of Furnace room

The Furnace room must be fitted with air supply and ventilation openings (at least 31 inch²/200cm²). In any case you must comply with the state and local regulations

3. Combustion air supply

The pellet Furnace needs a supply of combustion air. The supply of combustion air can:

- take place using one or more air supply and ventilation openings in total min. 31 inch².
- The air must not be used directly from the outside without preheating (background: This could lead to a condensation of the boiler).

Never operate the pellet Furnace if the air intake openings are partially or completely closed.

Contaminated combustion air can cause damage to the pellet Furnace. Never store or use cleaning detergents containing chlorine, nitrobenzene or halogen in the room where the heating system is installed, if combustion air is drawn directly from the room. It is recommended that no washing or drying of laundry is done in the Furnace room or where the Furnace may draw air from.

Do not hang out washing in the Furnace room.

Prevent dust from collecting at the combustion air intake to the pellet Furnace.

4. Damage due to frost and humid air

The Furnace room must be frost-proof to ensure trouble-free operation of the heating system. The temperature of the Furnace room must not fall below 37°F and must not exceed 90°F. The air humidity in the Furnace room must not exceed 70%.

5. Danger for animals

Make sure that household pets and other small animals cannot enter the Furnace room. Fit mesh over any openings.

6. Flooding

If there is a risk of flooding, switch off the pellet Furnace and disconnect from the power supply before water enters the Furnace room. You must have all components that come into contact with water replaced, before you start up the pellet Furnace again.

5.4 Flue gas system

The flue gas system consists of a chimney and a flue gas tube. The flue gas tube connects the pellet heating system to the chimney. The chimney leads the flue gas from the pellet heating system out into the open.

1. Design of the chimney

The dimensions and design of the chimney is very important. The chimney must be able to ensure sufficient draft to safely draw away the flue gas regardless of the status of the Furnace. Low flue gas temperatures can cause sooting and moisture damage on chimneys that are not insulated. For this reason **moisture-resistant chimneys** (stainless steel or ceramic) should be used. An existing chimney that is not damp-resistant needs to be renovated before use. Follow guidelines below:

Furnace size		Furnace
Flue gas tube diameter (at Furnace)	inch/mm	6.3/160
Flue gas temp. / rated power	°F	
Flue gas temp. / partial load	°F	
Min. draft - full load/part load	in/wc	- 0.04 / - 0.02

Chimney size	Min. Height
6in x 6in	17ft
7in x 7in	16ft
8in x 8in	16ft
6in round	19ft
7in round	17ft

NOTICE

Person(s) operating a pellet fired furnace is/are responsible for operation in a manner that does not create a public or private nuisance condition. The manufacturer's distance and stack height recommendations and the requirements in any applicable laws or other requirements may not always be adequate to prevent nuisance conditions due to terrain or other factors.

Recommended and UL-103HT approved chimney materials are:

- a. Selkirk sure temp
- b. Supervent (JSC)
- c. Security chimneys (secure temp ASHT)

Use flue gas pipe from chimney to Furnace as required by your local code.



CAUTION

Unregulated combustion

Please observe that combustion air openings and flue pipes are not reduced in size or closed. Make end user aware of these guidelines and their potential danger. Clean the chimney and the flue gas tube at regular intervals. Check if the draft inducer is clean and in a good condition.

2. Flue gas temperature

The flue gas temperatures are approximately the same for all AutoPellet Air covered in this manual.

The dewpoint of flue gas with wood pellets (max. 10% water content) is approx. 120°F.

It is possible to increase the flue gas temperature to prevent condensation inside the chimney and avoid damage due to damp. Only authorised installers may increase the flue gas temperature.

Note:

The increase in flue gas temperature results in reduced efficiency and thus increases fuel consumption.

3. Negative pressure of the chimney

The Furnace must be connected to a chimney or a vertical venting system that is capable of handling and producing a negative breaching pressure of -0.4 "WC. Use a draft gauge to verify the indicated draft value, adjust barometric damper as required. Drill a small hole in the connection pipe at about 2in/ 50mm from the Furnace flue outlet and use this hole as your measuring point.

Chimney draft

The suction effect of the chimney draft must extend all the way to the Furnace flue pipe connection. The maximum flow rate that can be drawn through the chimney limits the maximum performance of the chimney connection. The Furnace performance must be reduced if the chimney does not possess the necessary cross-section. This may only be performed by authorised personnel.

4. Power venter

AutoPellet Air are approved by the manufacturer for installation with the Field Controls SWGAF power venter which is approved for wood pellet burning appliances. Furnaces installed with SWGAF power venters must follow all manufacturer's installations and must comply with all applicable codes from agencies having authority over the installation.



5. Cleaning

Clean the flue gas tube and chimney regularly. Solid fuel burning appliances need to be cleaned frequently because soot, creosote, and ash may accumulate. The hotter the fire, the less creosote is deposited. Cleaning intervals can vary in warm periods due to this and become more frequent.



DANGER

Risk of chimney fire

Creosote-formation and need for removal: Low flue gas temperature can cause creosote. Creosote can condense in a relatively cool chimney. As a result, creosote residue accumulates on the flue lining. If ignited, this creosote will create an extremely hot fire. The chimney and the chimney connector should be inspected at least twice monthly during the heating season to determine if a creosote buildup has occurred. If creosote has accumulated it should be removed to reduce the risk of a chimney fire.

NOTICE

Oxidation of chimney

Do not use metal brushes to clean chimneys made of stainless steel.
Your state and local regulations must be observed.

5.5 Safety systems

The following safety measures are the prerequisite for safe operation of your system.

Emergency stop switch

Every heating system must be able to be switched off with an Emergency Stop switch. The Emergency Stop switch must be outside of the Furnace room.



Safety temperature sensor

The pellet Furnace is equipped with a safety temperature sensor. This is located on the pellet Furnace. If the Furnace temperature exceeds 230°F then the heating system switches off.



5.6 Installation with an existing Furnace

AutoPellet Air Furnaces are not to be connected to a chimney flue serving another appliance. However, when all State and local codes allow for the sharing of chimney flues, the AutoPellet Air Furnaces and another appliance burning pellets or a different fuel can be operated simultaneously while connected to a single existing chimney or flue gas system providing the following conditions are met:

- All state and local codes permit the specific installation
- All appliances are installed in accordance with the manufacturer's installation specifications or if lacking manufacturers specifications, the appliance in question is installed in a manner commonly recognized as safe and correct for the application and circumstances
- The chimney or flue gas system must be able to handle the combustion products of either appliance and both appliances when operated simultaneously

NOTICE

Avoid clearance issues that can make servicing difficult:
Be sure to follow suggested clearances when installing the AutoPellet Air Furnaces with an existing Furnace to be sure that service and cleaning can be performed adequately.



CAUTION

Avoid code violations:
When connecting to or with an existing Furnace, contact the authority having jurisdiction to be sure the type of installation planned is allowed.
Document the type of Furnace that the AutoPellet Air Furnace is connected to or with.

Pellet Furnace: Make and Model number:

Existing Furnace: Make and Model number:



DANGER

Possible escape of flue gas:
Do not connect this unit to a chimney flue serving another appliance unless multiple appliances into a single flue is authorized by all authorities having jurisdiction.

6 Fuel

Wood pellets are natural wood (dried sawdust or waste from machining) that has been formed into pellets under high pressure. They have a very low moisture content and very high calorific value. The manufacture of wood pellets is regulated by European standard EN ISO 17225-2.

6.1 Specification for high quality pellets as PFI (Pellet Fuel Institut)

Calorific value	min. 7200 BTU/lbs
Bulk density	min. 40 Lb/cft
Water content	max. 10%
Ash content	max. 1.0%
Ash melting point	at least 2192°F
Length	max. 1.5 inch / 40 mm
Diameter	1/4" - 5/16" / 6 - 8mm
Fine material	max. 0.5 %
Contents	100% untreated natural wood

NOTICE

The pellet Furnace is suitable only for pellets of natural wood that comply with PFI premium specifications. Using non-pelletised fuels or pellets that are not manufactured from natural wood will lead to the warranty becoming void and will cause damage to the pellet Furnace and the chimney.



WARNING

Never use pellets that contain treated wood, colored paper products, cardboard, solvents, plastic, trash or garbage
 Never burn trash, plastics, gasoline, solvents, naphtha, household garbage, material treated with petroleum products such as particleboard, railroad ties and pressure treated wood, leaves, paper products, cardboard.

6.2 Storing the pellets

1. Pellets are to be stored in a place where they are kept dry all year.
2. Install a back-ventilated partition to prevent pellets from contacting damp walls, or use a fabric tank.
3. Refer to our planning hints for pellet storage rooms and warning signs.
4. Legislation in your country must be observed regarding building specifications for storage rooms.
5. ÖkoFEN also offers FleXILO fabric tanks for storing pellets.

6.3 Measures for the ventilation of storage rooms

To avoid any kind of danger through possible degassing of the pellets, make sure you obey the following guidelines:

- The storage room has to be insulated towards the living area.
- The storage room has to be ventilated to the outdoors.

For further information please consult your expert adviser.

7 The pellet Furnace

The pellet Furnace is equipped with an automatic cleaning system and an ash box with ash compression system. The installed programmable logic controller system enables fully automatic operation and highest efficiency. We offer an optional automatic de-ashing system for the highest level of cleanliness and comfort.

AutoPellet Air types and power ratings

We offer the Pellet Furnace with the following power ratings:

Suction-feed systems: 95,000 BTU/hr

All sizes / outputs of the AutoPellet Air Furnace are available with external automatic ash compression system.

Note:

Refer to the data plate for the power rating of your AutoPellet Air. The data plate is located on the rear side of the AutoPellet Air. Here you will find the type designation, manufacturer's serial number and year of build.

Key components of the AutoPellet Air

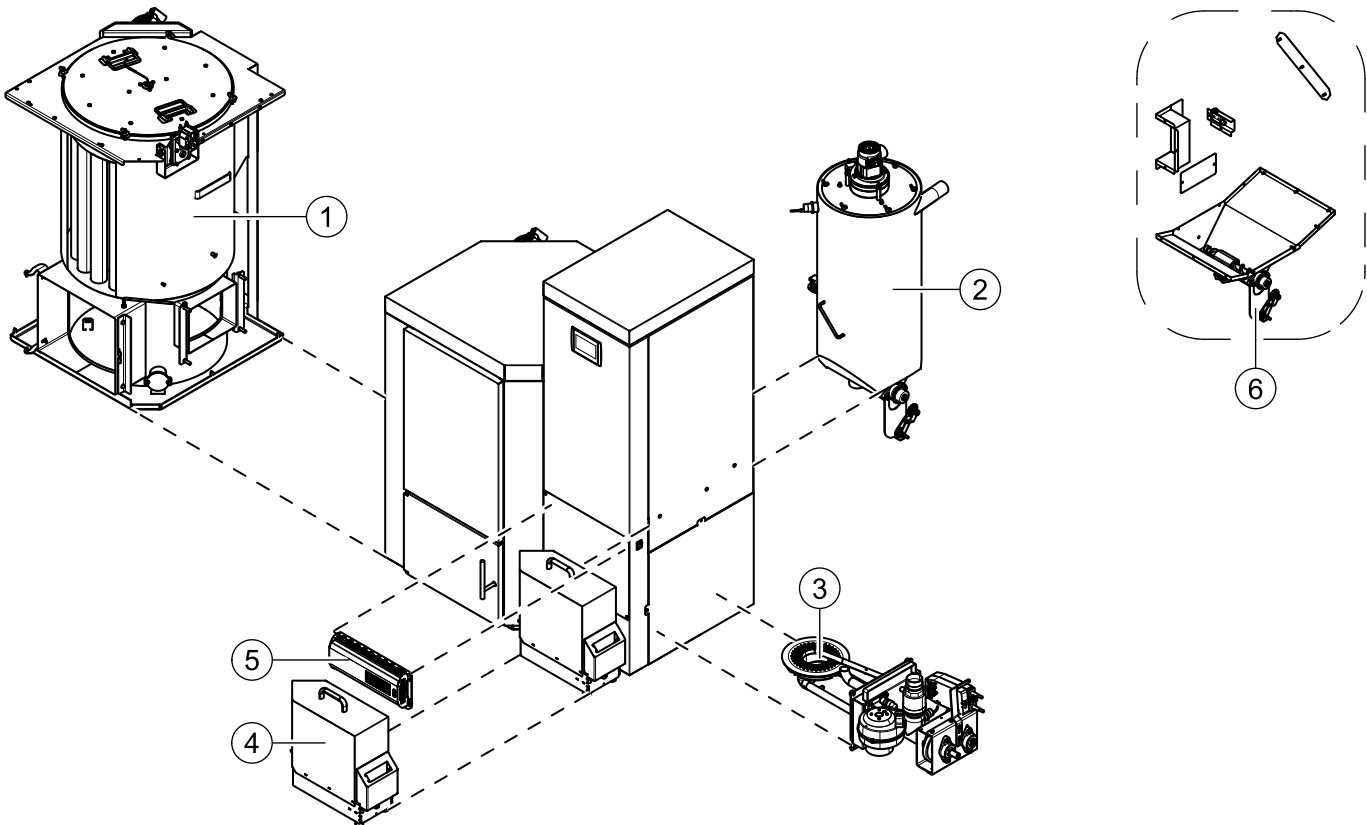

1	Furnace (heat exchanger)
2	Vac Hopper / Day tank
3	Burner
4	External automatic ash compression system
5	Furnace controller
6	Additional parts hand filling

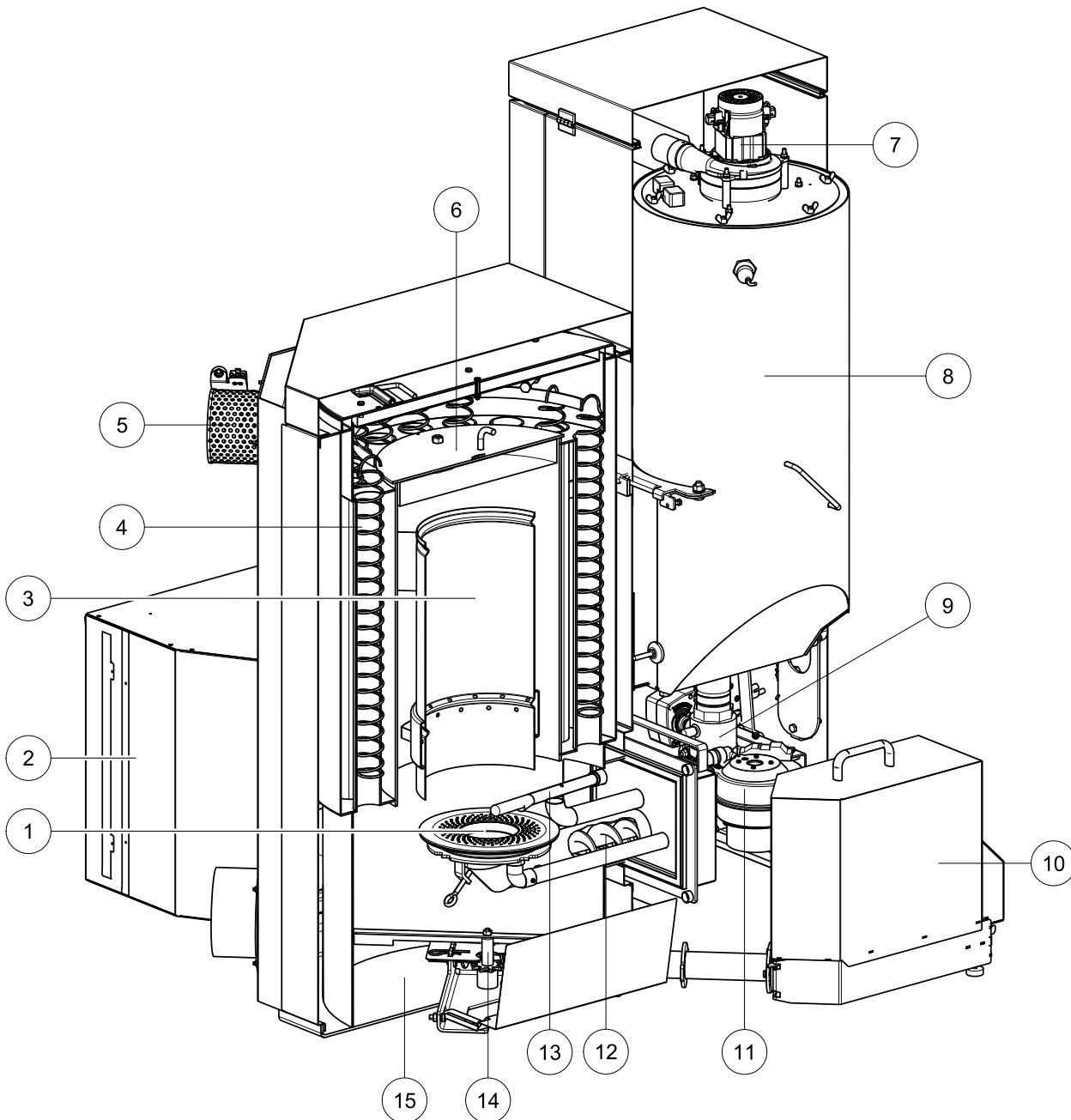

1	Burner plate	9	Fire protection - ball valve
2	Fan	10	External ash box (optional)
3	Flame tube	11	Burner fan
4	Heat exchanger	12	Burner auger
5	Flue gas fan	13	Electronic ignition
6	Combustion chamber cover	14	De-ashing system (optional)
7	Suction turbine	15	Ash chamber / Fire chamber
8	Vac hopper / Day tank		

7.1 Pellet suction system

The pellet suction system consists of a pellet line, an air line and a suction turbine. The suction turbine in the hopper conveys pellets in the pellet line from the storage room or textile tank to the hopper.

Key components of pellet suction system

1	Pellet hose	Hose from textile tank to the hopper.
2	Air hose	Hosee from the suction turbine to the textile tank.
3	Suction turbine	Located above the hopper underneath the AutoPellet Air burner casing.
4	Suction switch	Located underneath the textile tank.

Pellet Furnace

FleXILO textile tank

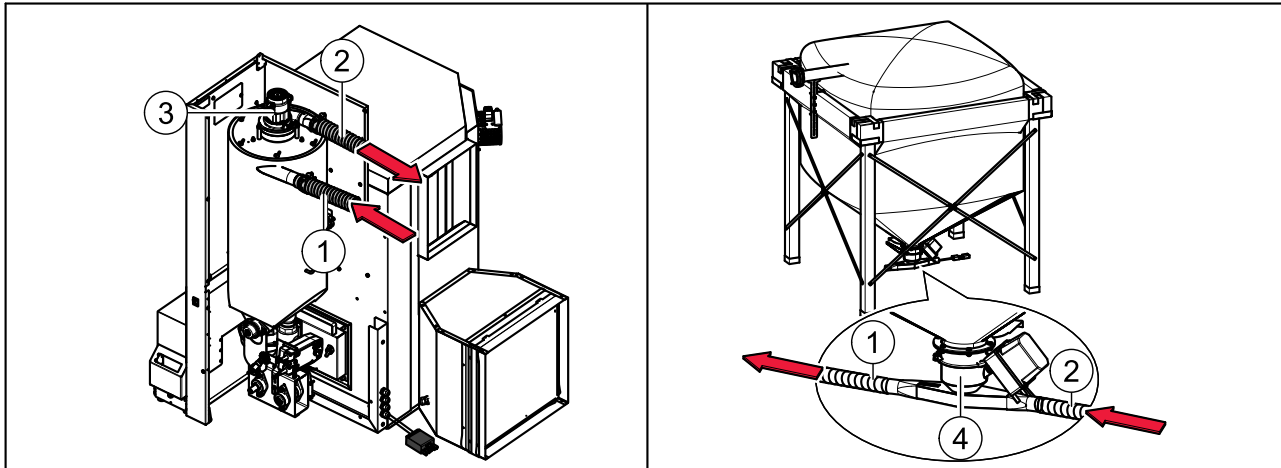

7.1.1 Assembly of the vacuum system

The pellet hose and the air hose are flexible spiral hoses made out of plastic. A copper braid avoids the static loading of the spiral hose.

To avoid damage to the spiral hose, you must observe the following assembly guidelines:

- Bending radius** The hose should be led as briefly as possible and with a few curves as necessarily. Bending radius may never be smaller than **12 inch**.
- Upward gradients** Max difference in height = **19 feet**
Note: A difference in height of up to 10 feet can be overcome at one time. Larger differences in height must be interrupted with a 4 foot horizontal run of the pellet hose.
- Impact protection** The spiral hose can be mounted up to 19 feet exactly straight. In such cases however, it is very important to create a slight "S" in the pellet piping before a sharp curve to slow down the pellets to prevent hose damage.
- Installation in the soil and openings:** When installing pellet lines underground remember! The pellet lines are not designed for direct burial and require protection from being crushed or chewed by varmints. Protective piping should be minimum 4 inch and sealed at each end. There should be no bends greater than 15 degrees in the underground sections of the pellet hose.
- Tightness** To avoid problems with your pellet lines, it is important to have all hose connections secured completely air tight with hose clamps.
- Static neutralization** The hoses are provided with a copper braid, those the hose keeps antistatic. In order to ensure the function of the anti-statics, those copper braid must be attached at each end to the existing grounding become.
- Fire protection** At a wall break-through to the heating room must be installed a fire protection seal in the pellet- and the air hose.

Crossing The pellet hose and the air hose should cross each other as few times as possible.

Length of the spiral hose The maximum total length of the spiral hose is 130 feet.
The maximum for pellet hose and air hose are each 60 feet.

Assembly

Use securing clips and carrying bowls.

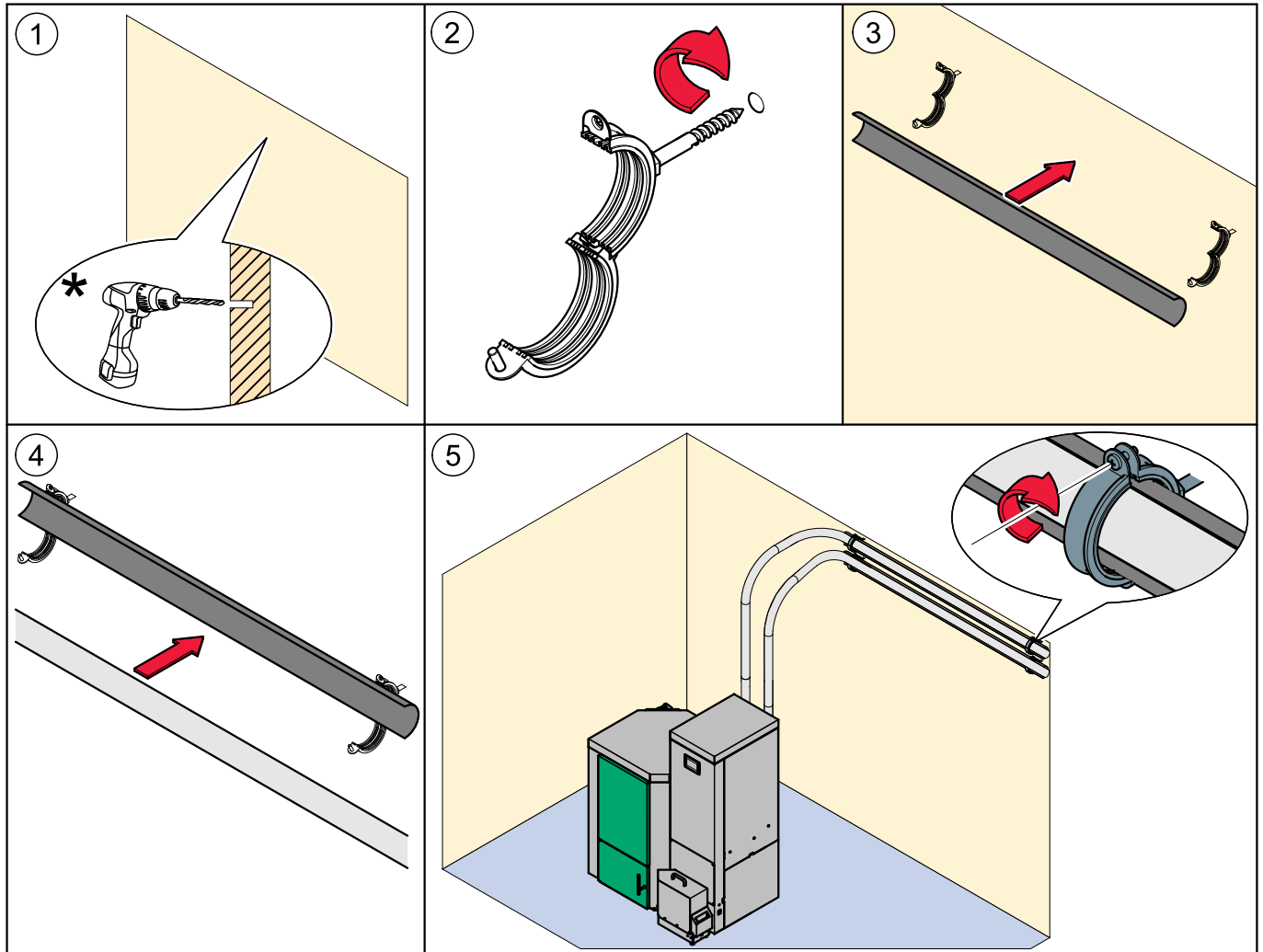

*Pay attention to the defined distances!

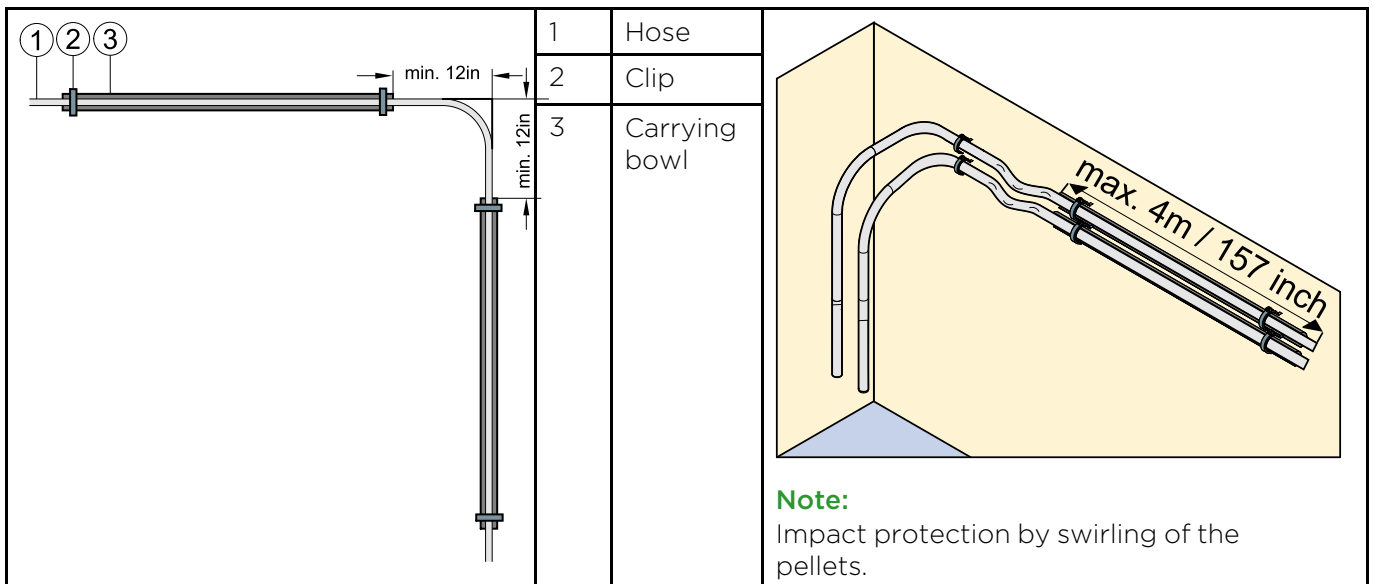

Connection of the pellet and air hose to the suction turbine

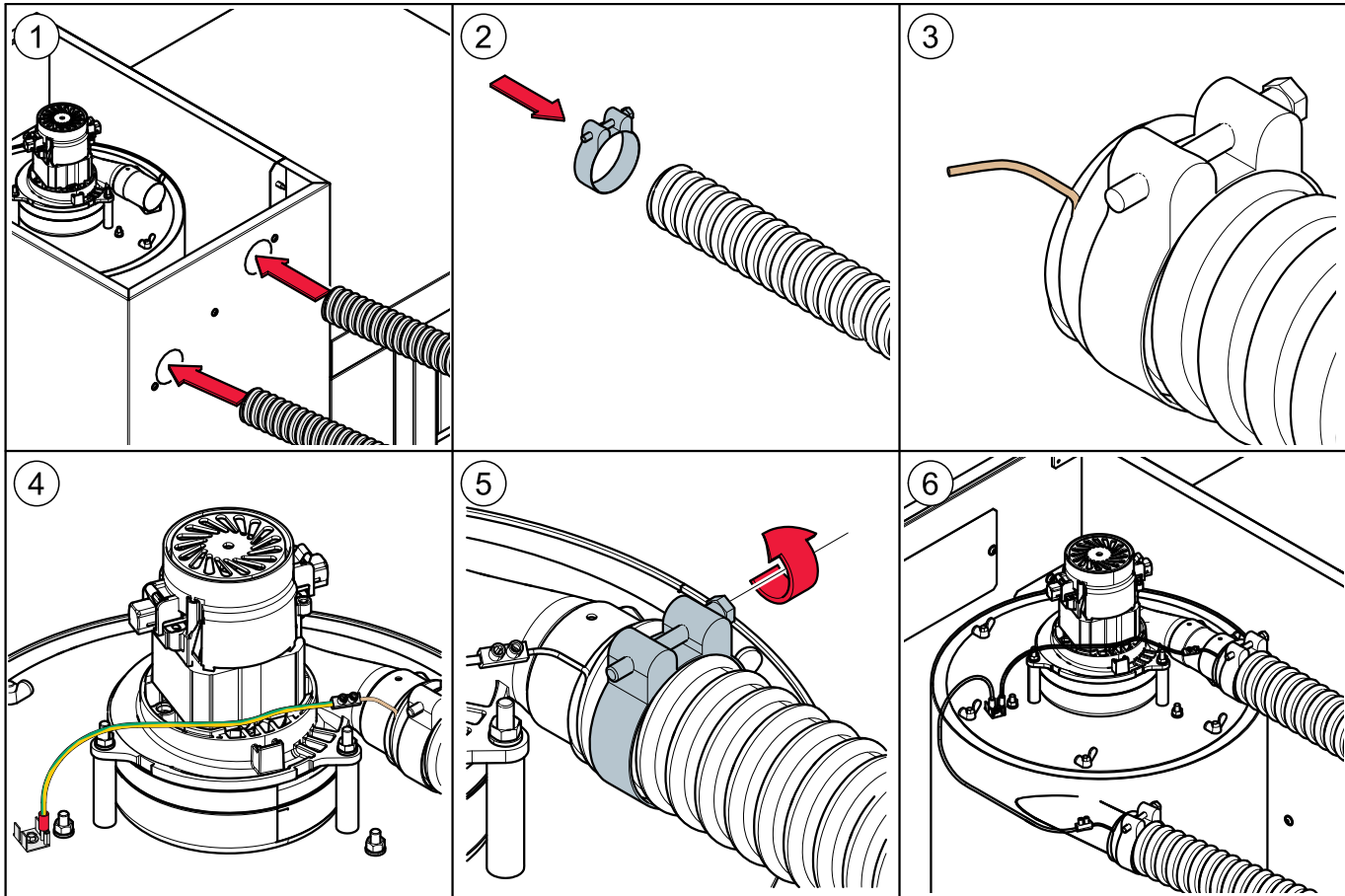

7.2 Storage systems

For storing pellets we offer a FlexILO textile tank. FlexILO textile tanks can be located inside the Furnace room, storage room or protected from wet and sun outside.

NOTICE

Damage to property and loss of warranty

The use of an AutoPellet Air Furnace with a storage or conveyor system from another manufacturer is not permissible and will result in voiding your warranty along with undependable operation.

7.2.1 Flexilo textile tank

Maine Energy Systems offers various sizes and types of fabric tanks. The fabric tank supplied may vary from the example shown above.

Please refer to the installation instructions supplied for the fabric tank. Note also the instructions on setting up and filling.

8 Operating the Furnace

The pellet heating system is an automatic heating system. All pellet feed system and combustion system sequences are regulated automatically using an electronic Furnace controller.

8.1 Operating the heating system

NOTICE

Damage caused do to incorrect operation or incorrect settings.

Only trained operators may use the heating system. Make sure no unauthorised persons enter the central heating room. Keep children away from the central heating room and storage room.



DANGER

Fire risk

Keep the ash removal door closed while the Furnace is in operation.

NOTICE

Standby mode Furnace controller

Don't set the main switch of the Furnace controller outside of the heating period to Off, because no buffer battery is used.

8.2 Description of the control panel

The control panel is located underneath the flap above the door of the Furnace.

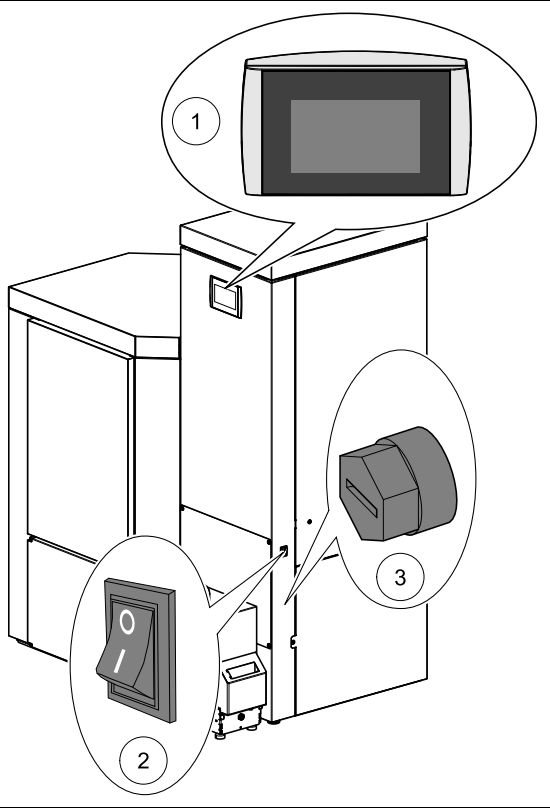
	1	User control unit	Operates the Furnace controller.
	2	Main switch	Switches off the heating system (both poles) including the power supply to the control panel.
	3	Safety temperature sensor	Switches the heating system off, if the Furnace temperature exceeds 203 °F.

8.3 Setting language, date and time at Pelletronic Touch

Setting the language (The factory setting for the language is German)

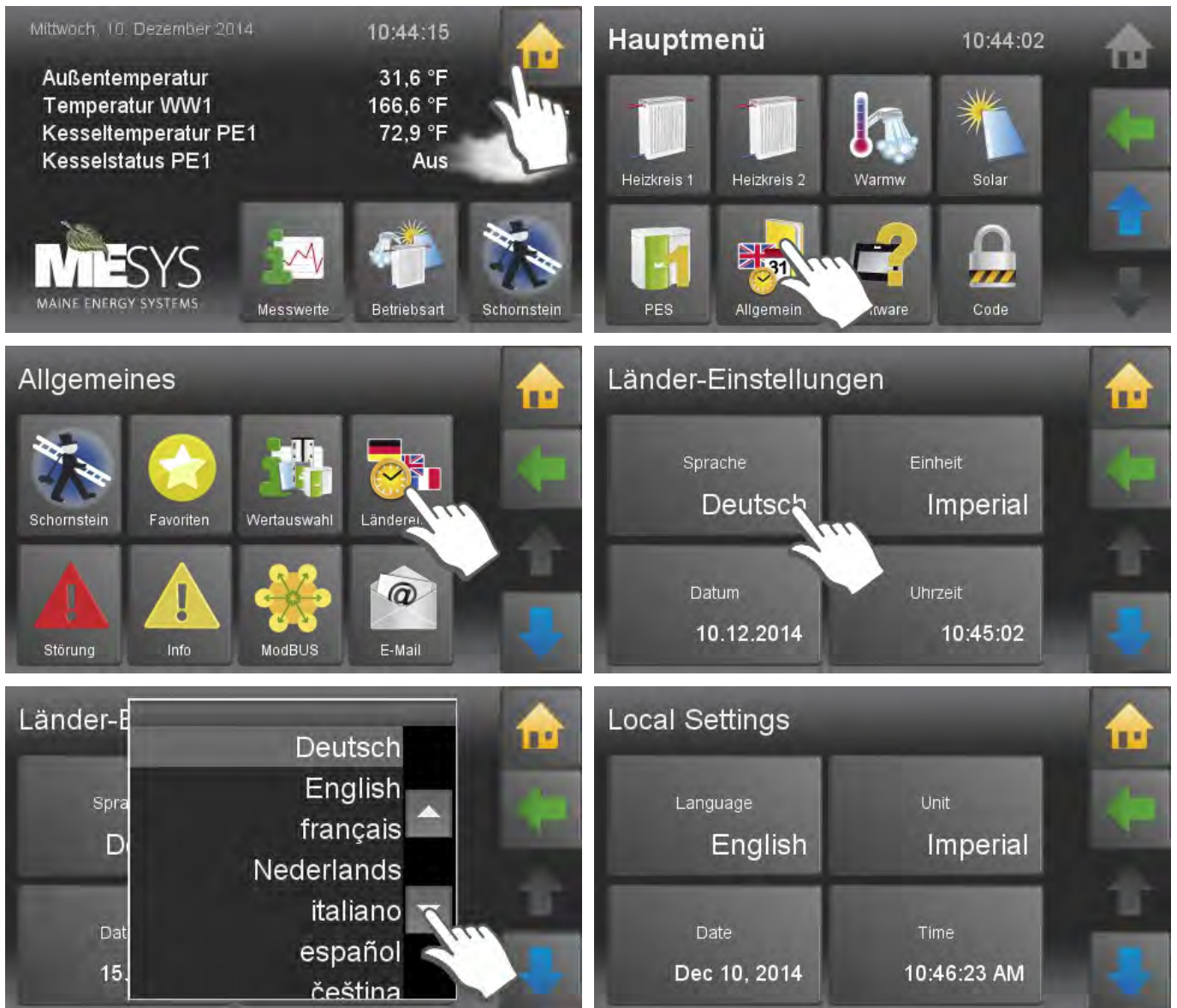

Setting the date



Setting the time



8.4 Emptying the ash pan

CAUTION

Risk of burns
Do not touch the Furnace vessel. Use gloves.

DANGER

Risk of fire
Bring out the ash pan immediatly.
Do not dispose ash until it has completely cooled down.
Empty ash only into a not flammable steel container.
Do not use ash container to store waste or other material.
Do not empty ash onto flammable floors or materials.

Emptying the ash pan

Note:

Check the level of the ash pan and empty it at regularly intervals (at least every 2 weeks). No warning is displayed indicating that ash pan needs to be emptied when it is full (unlike external ash box)

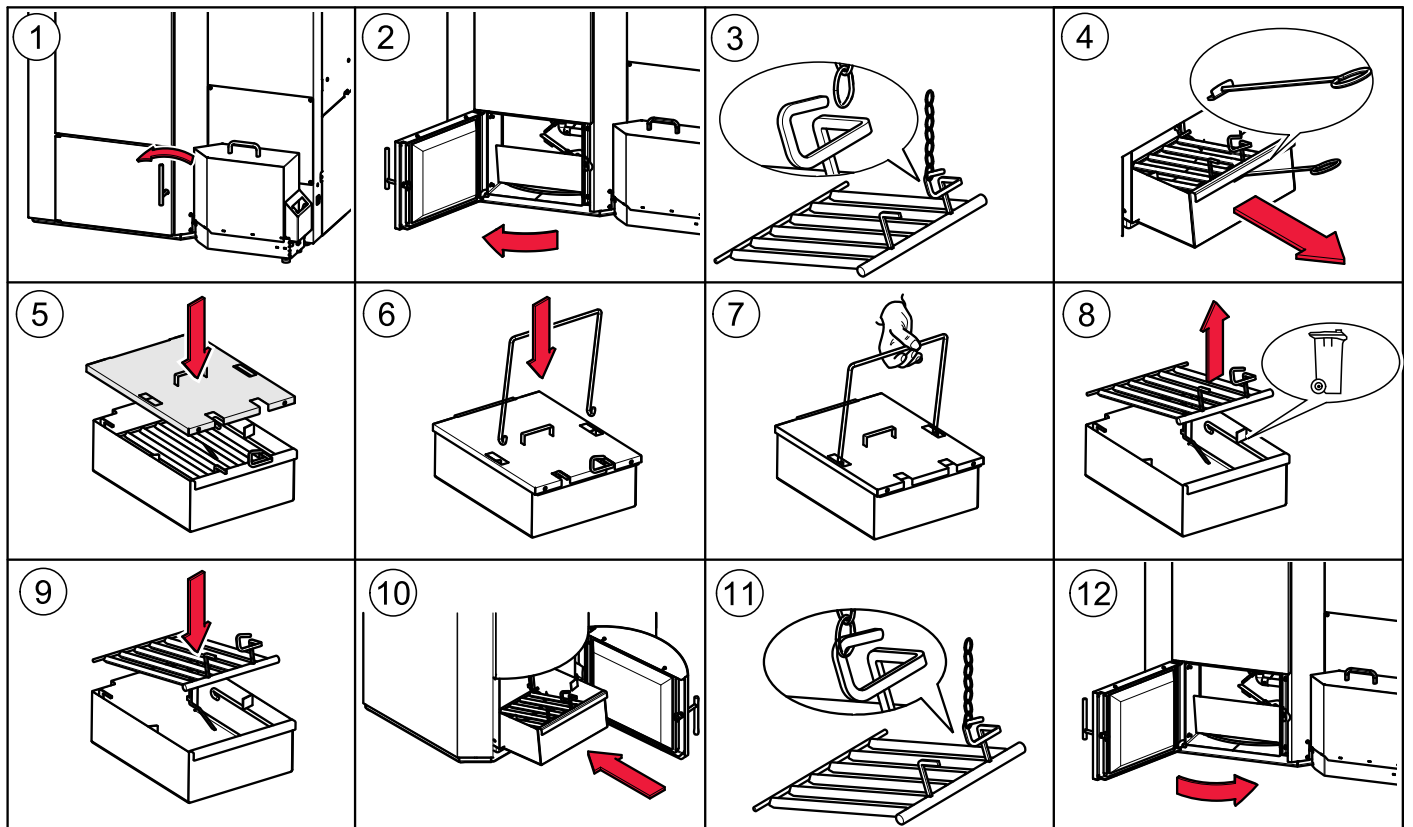
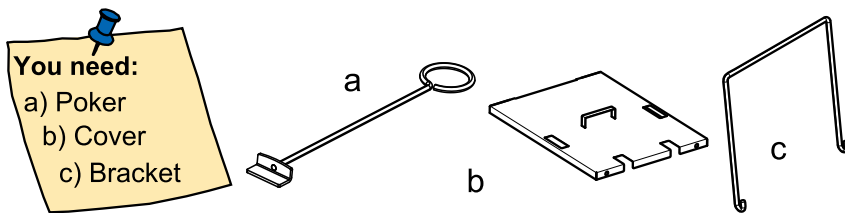

* No riddle grate for systems with burner plate cleaning system.

8.5 Emptying the ash box

Only on Furnaces with external ash box. We also offer an optional automatic external ash box. This compresses the ash and reduces the frequency at which it needs to be emptied. It enables the ash to be disposed off without creating dust. Installation is performed by the service technician when the pellet Furnace is installed. An external ash box can also be retrofitted.

NOTICE

Damage to property

Empty the ash box before a longer off-time of the Furnace. Otherwise the auger and the opening mechanism can be blocked through firmly bonded ash.



DANGER

Risk of fire

Bring out the ash box immediately.
Do not dispose ash until it has completely cooled down.
Empty ash only into a not flammable steel container.
Do not use the ash container to store waste or other material.
Do not empty ash onto flammable floors or materials.

Emptying the ash box

Note:

When the ashbox is full then **Ash!!!** appears on the display with the alarm text **Ash box full**. After emptying and restarting the ash box the alarm text disappears automatically.

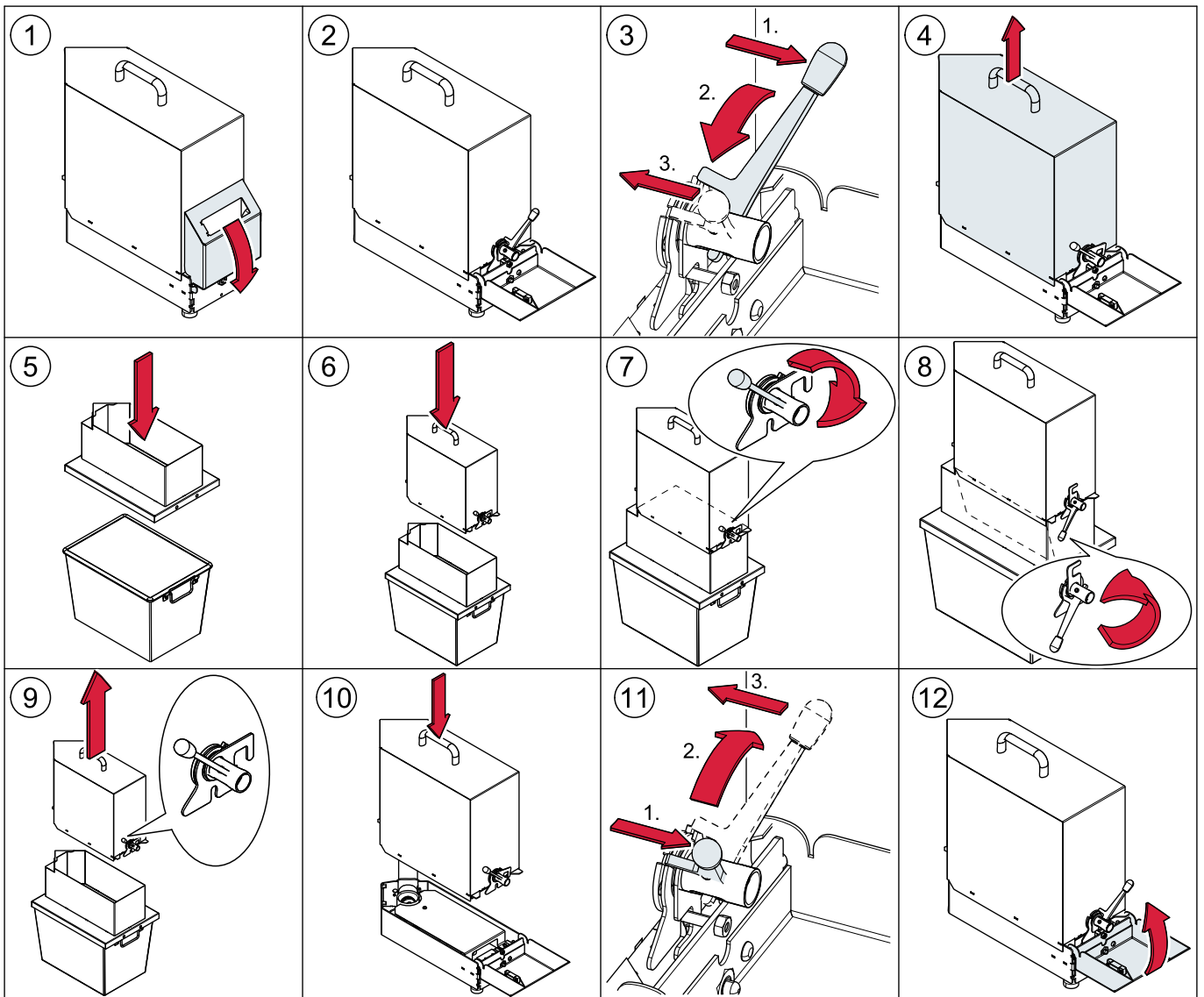
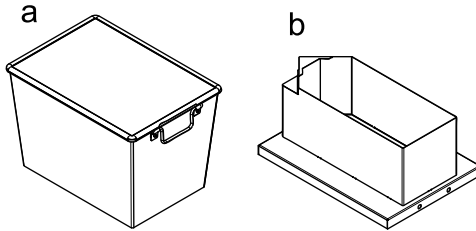
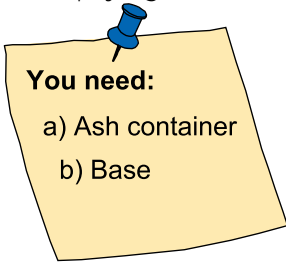

9 Operating Device with Touch screen

The Touch operating device is mounted on the control board of Furnace. The 4.7" color display is surrounded by a foil design with logo. With finger pressure you make settings on the Touch operating device.

9.1 Opening window

The touch panel is dark during in standby mode. As soon as you touch the surface of the touch, light turns on and displays the opening window.



- 1 Measuring values (adjustable)
- 2 Date
- 3 Hour
- 4 The icon house takes to the main menu
- 5 Weather

Note:

If there is a malfunction, the corresponding fault message is displayed at this point instead of the weather icon

- 6 Favorite 1 (adjustable)
- 7 Favorite 2 (adjustable)
- 8 Favorite 3 (adjustable)

9.2 User controls and their function

1. Navigation-icons

Icon-view

If you touch an icon, the icon turns green. The green shows that you are currently on this icon. You get to the enabled menu item .

The yellow house enters you directly to the main menu.



The horizontal arrow leads you one step back.



With the blue down arrow you get to additional lines of information on this item. (Down - scroll down).



With the blue up arrow you get to additional lines of information on this item. (Top of page - scroll up)



You get to the respective menu item.

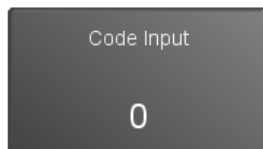

You get to the settings of the parameter. You come either to a numeric keypad, a time / date block or the text selection.

2. Numeric keyboard

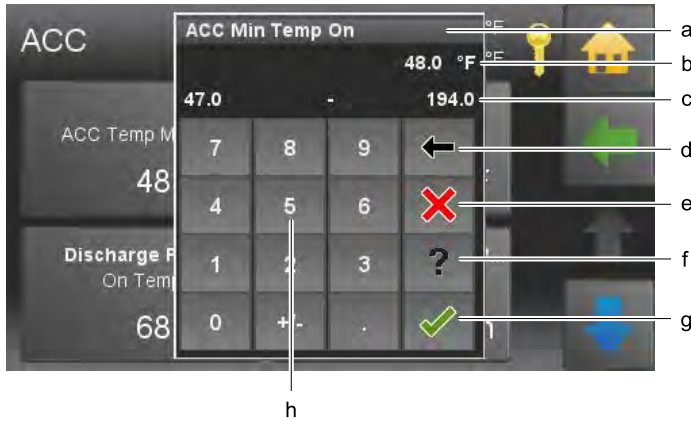

- a. Name of parameter
- b. Value of parameter with unit
- c. Min/max value - Values outside this range are not accepted.
- d. Delete input of numbers - per contact you delete one place.
- e. Cancel - You return to the menu item. Input of a new value was not accepted. The original value is.
- f. Help function - inactive
- g. Confirm
- h. Numeric keyboard - used to enter values within the min - max range.

3. Time and date block

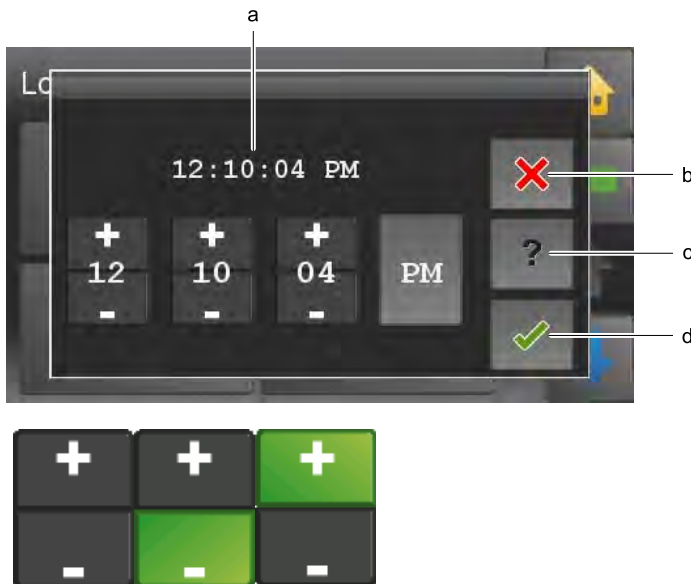

- a. Adjustable time or date
- b. Cancel
- c. Help function - inactive
- d. Confirm

With the Plus Minus block you change numbers.

4. Text selection



- a. Name of parameter
- b. Status texts
The number of status texts depends of the parameter.

Choose a status text. The setup menu closes automatically and the chosen status text is displayed in the menu.

Note:

Although a scroll down menu is open, the navigation icons, menu items and parameters behind are active and by touching them it takes you directly there .

9.3 Main Menu

In the Main menu you see all submenus. By finger pressure on an icon you reach the respective submenu.

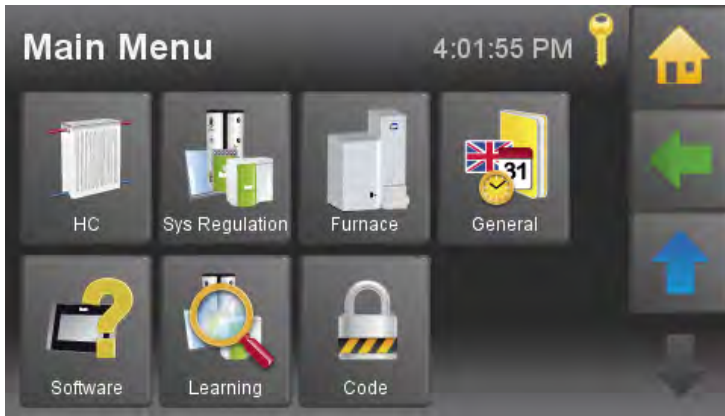

Menu navigation of Pelletronic Touch

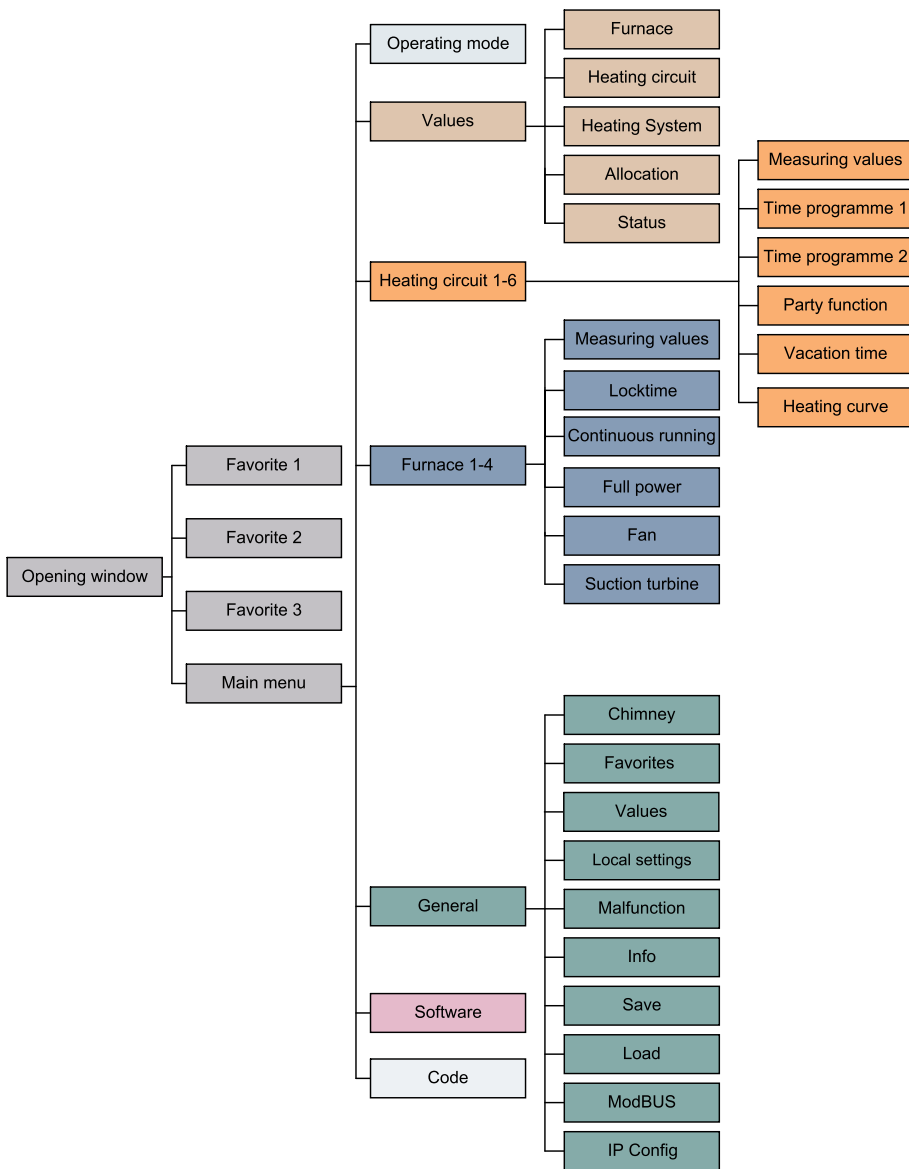

10 Mode

In the menu item Mode you can see the mode of your heating system and the mode of the heating circuits.



The menu item **Mode** is in the Main menu.



Overview of the operating modes

- Heating Plant
- Heating system 1-6 .
- Furnace

Choose the operating modes and make settings.

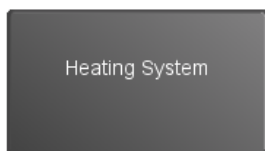

Off

The adjusted operating mode of the heating circuits is inactive.

The operating mode heating circuits and Furnace are described in the respective chapters.

11 Measuring Values

In the menu item of Measuring Values you see all actual and set values of your heating system.



The menu item **Measuring Values** is in the Main menu.

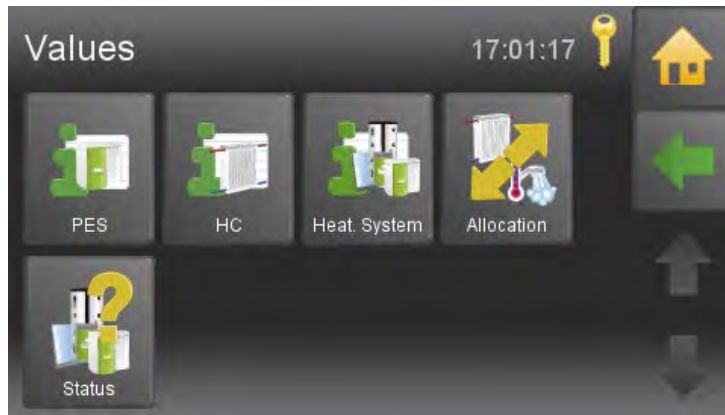

- Furnace
- Heating circuit
- Heating Plant
- Allocation
- Status

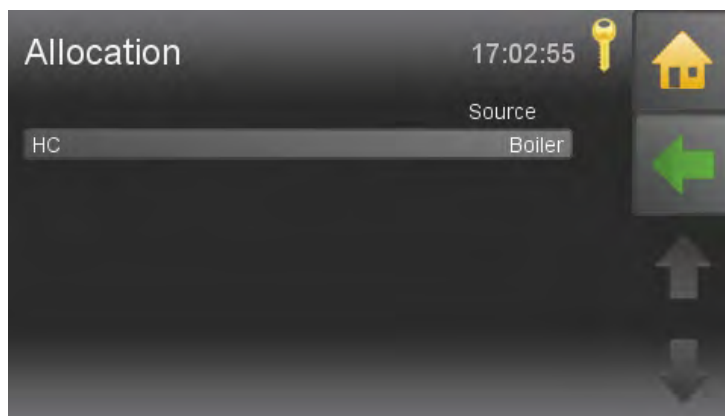

In the menu item **Allocation** you see which heating circuits are allocated to the Furnace or to the accumulators.

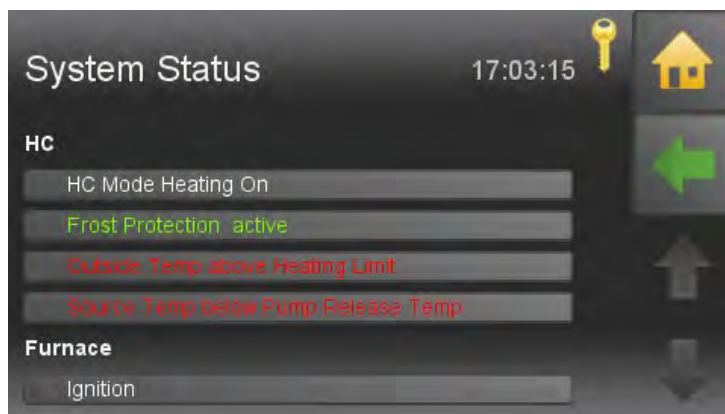

In the menu item **Status** you always have an overview about the whole heating system.

12 Weather



Choose **Settings** (), to enter your location.



Enter location and country. If the specified location is not found, enter a larger, nearby place.

Search with the following details:

- Postal code, location, country
- Postal code, country
- Location, country



Afterwards, weather data for the next 3 days are downloaded. An icon for the current weather is displayed on the opening window.

Note:

This feature requires an internet connection.

13 Eco Mode

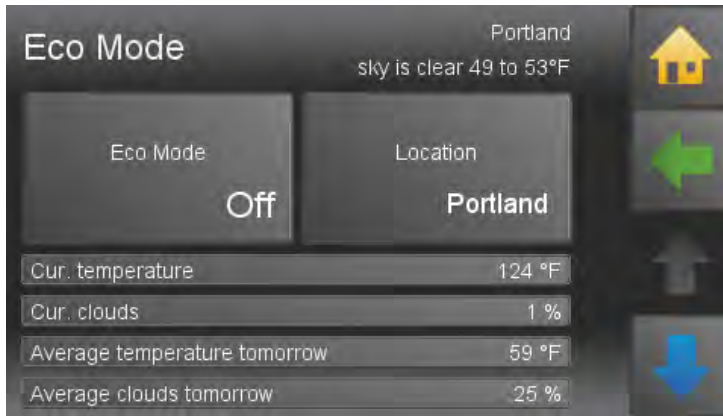

With the Eco Mode, the influence of weather forecasts can be defined.

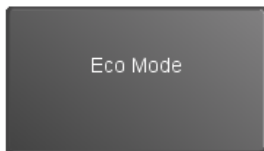

- Off:** Eco mode inactive.
- Comfort:** Set temperature minus 0.9 °F
- Minimum:** Set temperature minus 1.8 °F
- Ecologically:** Set temperature minus 2.7 °F

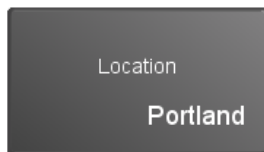

Enter location and country. If the specified location is not found, enter a larger, nearby place.

Search with the following details:

- Postal code, location, country
- Postal code, country
- Location, country

Afterwards, weather data for the next 3 days are downloaded. An icon for the current weather is displayed on the opening window.

Note:

This feature requires an internet connection.

Cur. temperature

Current temperature according to forecast.

Cur. clouds

Current clouds in % according to forecast.

Average temperature today / tomorrow

Calculated temperature for the forecast period

Average clouds today / tomorrow

Calculated clouds for the forecast period

Sunrise / sunset

Time at sunrise or sunset

Starttime/ Endtime

In this time frame, the Eco Mode affects the heating settings.

Last update

Time of last update of the forecast.

14 Heating Circuit

Heating Circuit encloses all for heating relevant parameters and settings. It can occur up to 6 menu items **Heating Circuit**.



Heating Circuit is in the Main menu



Heating circuits settings has following menu items:

- Mode
- Room Temp Heating
- Room Temp Set back
- Time Allocation
- Values
- Time 1
- Time 2
- Party
- Vacation
- Heatingcurve

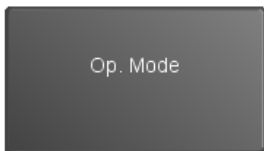

Off Only the frost protection function is active.

Auto The Furnace starts in the heating times according to the Set room temperature.

Heating The Furnace heats constantly according to the Set room temperature.

Set back The Furnace heats constantly according to the Set back room temperature.

The operating mode of the heating circuits can only be changed if the plant operating mode is set to AUTO.

The adjusted heating limits and maximum flow temperatures are used in all operating modes.

Choose your room temperature (Temperature within the heating times).

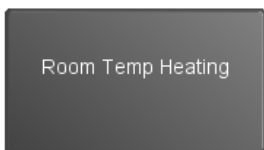

Choose Room Temp Set back (= Minimum temperature beyond the heating times).

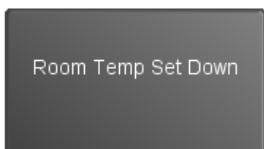

Activate **Time 1** (= Time programme 1) and **Time 2**.

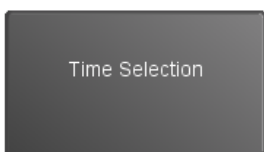

14.1 Measuring values Heating circuit



Measuring values HC is in the Main menu.

Values		9:58:36 AM	
HC		Act	Set
Outside Temperature	-0.3 °C		
Boiler Temperature	24.7 °C	8.0 °C	
Burner Contact	Off		
Existing Boiler	60.5 °C		
Switching Valve	On		
HC1 Flow Temperature	14.3 °C	28.9 °C	
HC1 Pump	On		

You see all to the Heating circuit corresponding measuring values:

- Actual value
- Set value
- Inputs (sensors)
- Outputs (pumps, mixer and motors)

Outside Temperature	actual Outside Temperature
Furnace Temp	actual Furnace Temperature
Existing Furnace	actual Temperature of available Furnaces
Booster	Status (Booster On/Off)
Flow Temp	display of the flow temperature
Room Temp	display of the room temperature
Pump	Status (Pump On/Off)
Mixer	Status (Mixer On/Off)

14.2 Time programme Heating circuit

In the heating circuit time programme you fix the heating times.



Time 1 (=Time programme 1) and **Time 2** are in the menu Heating circuit.

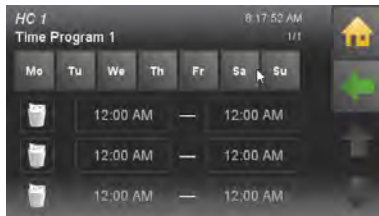

1 Select Time programme 1

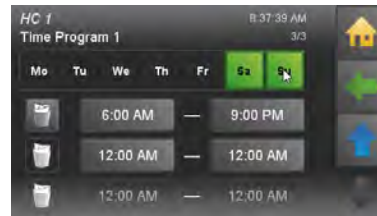

6 Mo-Fr were assigned heating times

With  you get to the remaining days Sa-Su.



2 Select the heating days.
The activated days are deposited in green.

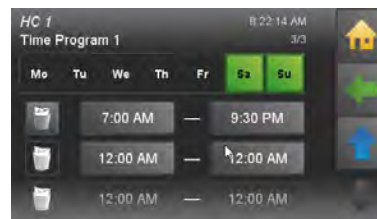



7 Sa-Su were assigned to heating times.



3 Enter the heating times for these heating days (Mo-Th).



8 With  and  you switch between the heating blocks. You can deactivate heating days in the heating block and activate in another.



4 The heating times for Mo-Th are assigned. With  you assign to days heating times further.

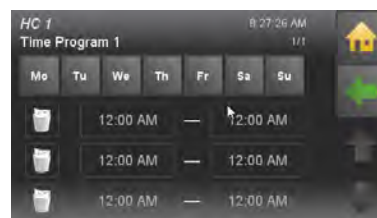

9 With  you set all the heating times in the line and below to 0.



5 Friday was activated. Heating times were assigned.



10 Go back with . Choose Time 2. For every heating circuit there are 2 time programmes. You can programme 2 time programmes. In the menu item **Time Allocation** you can activate time 1 or time 2.

14.3 Party

The party function extends the heating time once, without changing the heating times.



Party is in the Main menu.

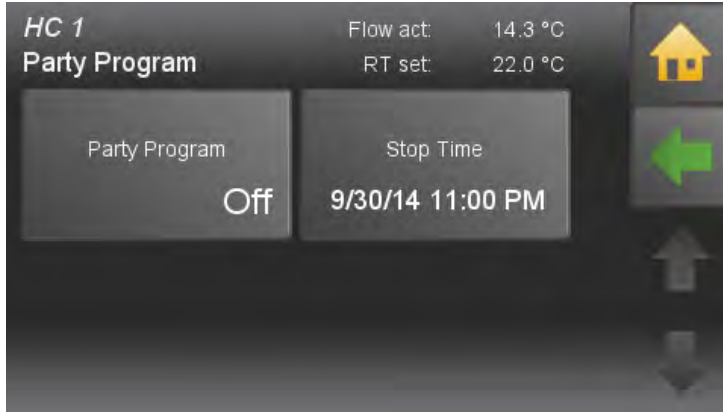

The party function is basically inactive. Enter the time until the room temperature heating should be heated. Activate the Party function. The heating time is extended up to the indicated time. Then the party function deactivates itself automatically.

14.4 Vacation

The holiday programme cancels the heating times and heats for the entered period on the set temperature level.



Vacation is in the Main menu.



Enter the room temperature on which in your absence the building should be heated. Enter the departure (start time) and return (finish date) and activate the vacation programme.

Note:

To return in an already tempered building, you must enter the day before the return as the finish date.

14.5 Heating curve and Heating limits

By starting up the first time, the authorised technical adviser adjusts the heating curve, the base point and the heating limits on the building situation and the hydraulics. If the Set room temperature is not reached or exceeded, adjust the heat curve with the flow temperatures according to outside temperatures.



Heating curve is in the menu Heating circuit.

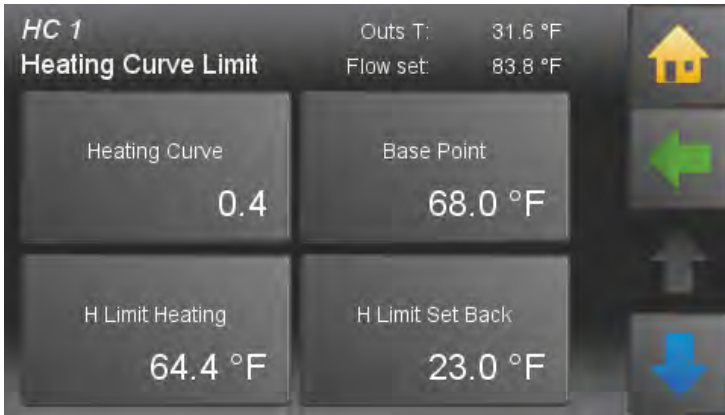

Heating curve 0.0 - 4,0

The heating curve describes the combination between outdoor temperature and the associated flow temperature for a heating circuit.

Base point adjustable from 68 - 113°F

With the change the of base point, you provide a parallel shift of the heating curve.

H limit heating

If the average outside temperature is higher than the set temperature, the heating circuit switches off in the heating mode.

H limit set temperature

If the average outside temperature is higher than the set temperature, the heating circuit switches off in the Set back mode.

Adjustment of heating curve and the base point to the building

Because of the building's thermal inertia, it is recommended to perform no more than one adjustment step per day.

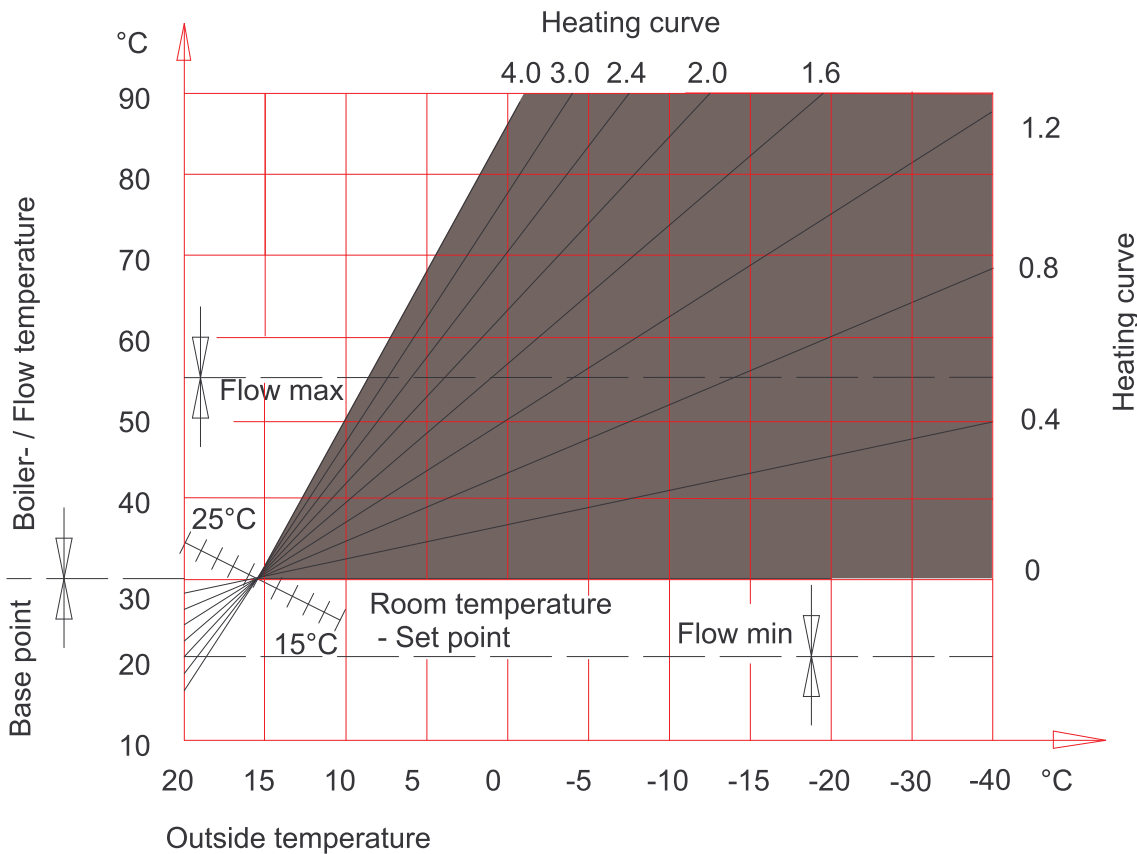

Daytime outside temp	Room temperature	
	too warm	too cold
+5 to +15°C	Decrease heating curving value by 0,2	Increase heating curving value by 0.2
	Decrease base point value by 5°	Increase base point value by 5°
-20 to +5°C	Decrease heating curve value by 0.2	Increase heating curve value by 0.2

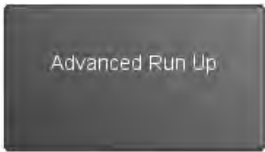

The advanced run up indicates how long the system has to heat before the start of the heating time, to reach the adjusted **roomtemp heating**.

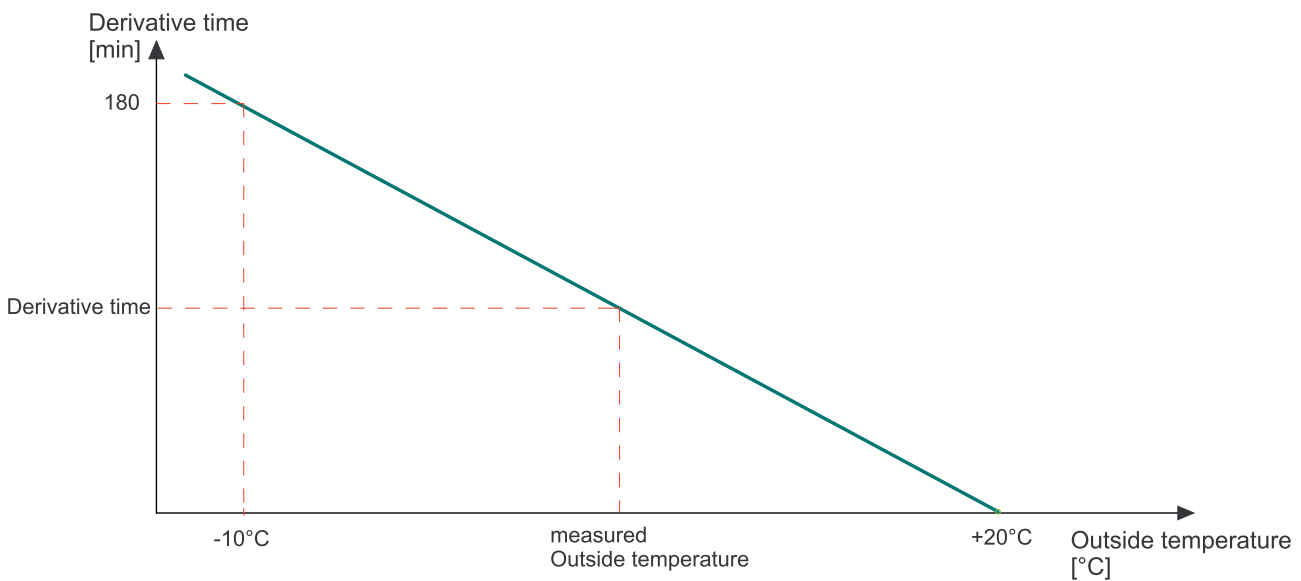

Room thermostat influence

If the measured room temperature deviates from the set room temperature, the heating controller corrects the flow temperature with the Room thermostat influence. The Room thermostat influence indicates how much the flow temperature is raised or lowered so that the Set room temperature is reached.

Example:

Room temperature desired value = 20°C

Room temperature actual value = 18°C

} Temperature difference 2°C

Room sensor influence = 3

Room sensor influence	*	Temperature difference	=	Advanced run up rise/reduction
3	*	2	=	6°C

Room temperature hysteresis

The Room temperature hysteresis prevents the cycling (On Off On Off...) of the heating circuit pump: If the Set room temperature + room temperature hysteresis is reached, the associated pump stops. If the Set room temperature is -1°C , the pump switches on again.

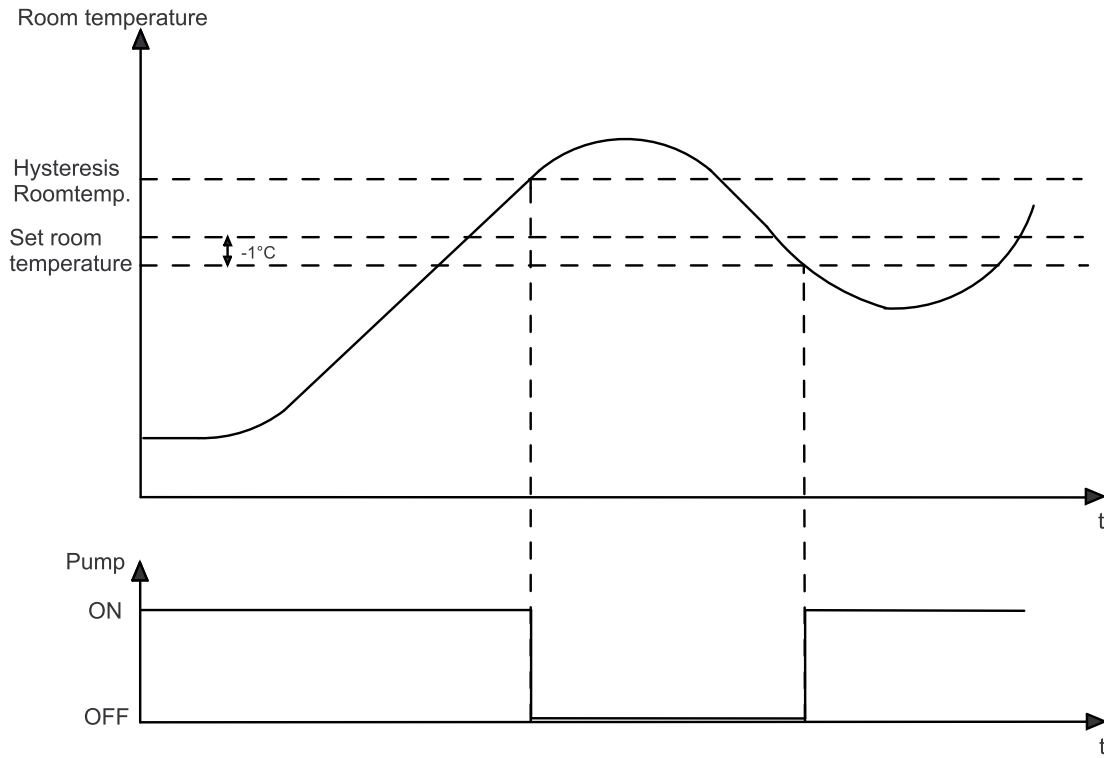

15 Furnace

Furnace includes all the relevant parameters and settings for the control of the pellet Furnace. There are up to 4 Furnaces possible.



Furnace is in the Main menu.



Furnace has following items:

- Operation Mode
- Measuring values
- Locktime
- Continuous running
- Full power
- Filling level
- Fan
- Suction turbine

15.1 Measuring values



Measuring values is in the menu Furnace.

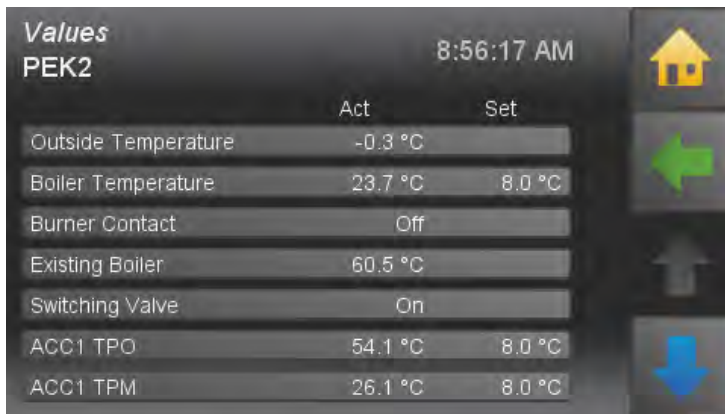

It displays all measuring values of Furnace:

- Actual values
- Set values
- Inputs (sensors)
- Outputs (pumps, mixer and motors)

15.2 Locktime



Locktime is in the menu Furnace.



15.3 Continuous running



Continuous running is in the menu Furnace.

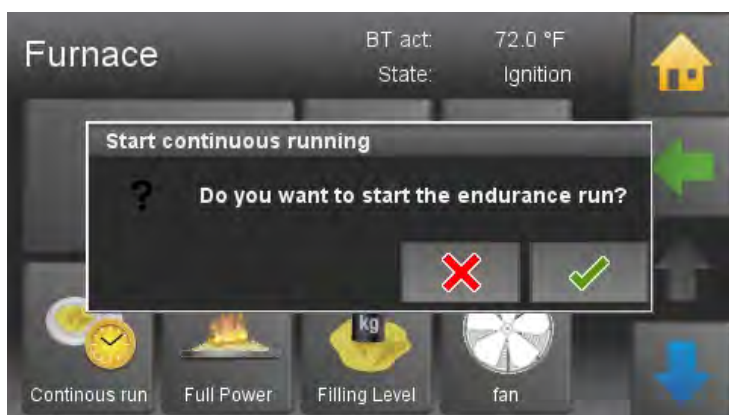

First of all, the spring-driven motor opens the fire protection system at the burner- the process takes about 2 minutes.

After that the burner motor runs in permanent operation and transports pellets to the burner plate.

If you confirm the query, you activate the function **continuous running**.

15.4 Full Power



Full Power is in the menu Furnace.

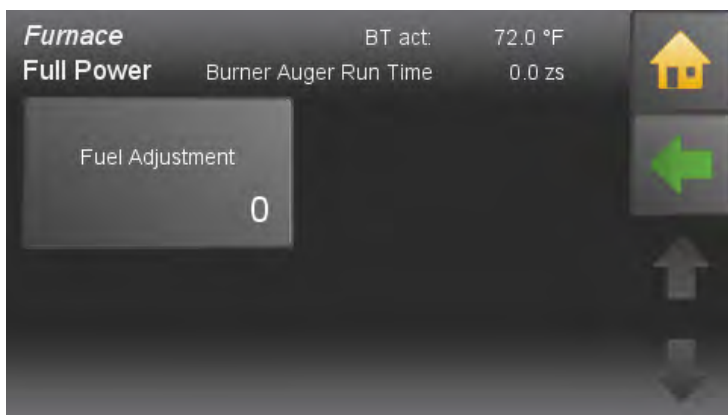

In the menu item Full Power can you adjust the fuel feed.

Fuel Adjustment:

The burner auger run time is calculated automatically by the PLC depending on the rated power and the Furnace setpoint temperature. The burner motor is controlled accordingly. You can reduce or increase the value calculated by the PLC 10 steps up or down.

15.5 Fan



Fan is in the menu Furnace.

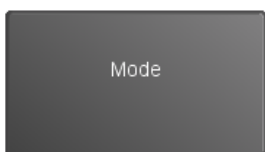

- Off:** Function fan inactive.
- Auto:** The function of the fan or blower is automatic.
- On:** Function fan active.

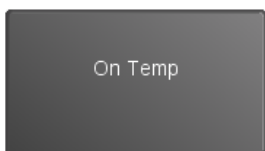

When reaching the **On Temp**, the output UW is activated respectively the fan is switched on. The On Temp is the Furnace temperature minimum.

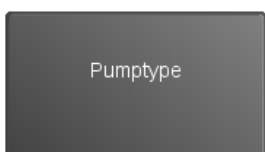

The menu **Pumptype** contains the following entries:

- Asynchronous:** Asynchronous pump - direct output 230VAC on/off
- Async.Regulated:** Asynchronous pump - pulsed output 230VAC
- Heating Efficient:** PWM1 - PWM signal inverted
- Solar Efficient:** PWM2 - PWM direct signal

Note:

When using an A-class pump as a **accumulator pump**, the pump can not be regulated from solar circuit 2.

NOTICE

Material damage by choosing the wrong pump type.

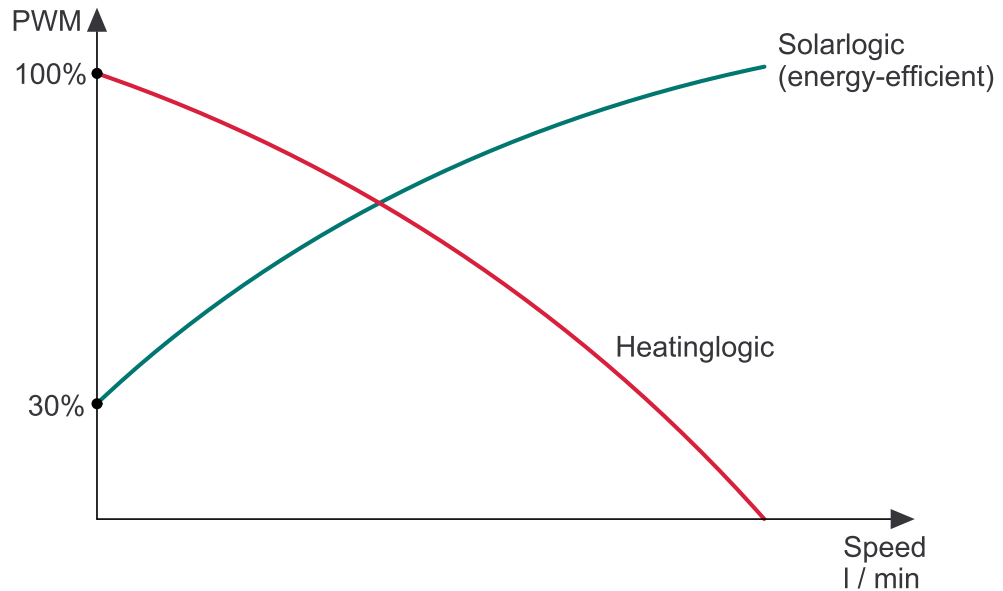

Switch Off Hyst

The pump switches off after falling below the **On Temp** from minus **Switch Off Hyst**.

Control Range

Is the **Control Range** of output UW at cycling mode. The speed controller starts at the Furnace temperature minimum with a speed of 30% and increases to the Furnace temperature minimum + **Control Range** up to 100% speed.

15.6 Suction turbine



Suction turbine is in the menu Furnace.

Note:

The menu item **Suction turbine** is only visible in suction systems.

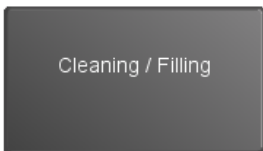
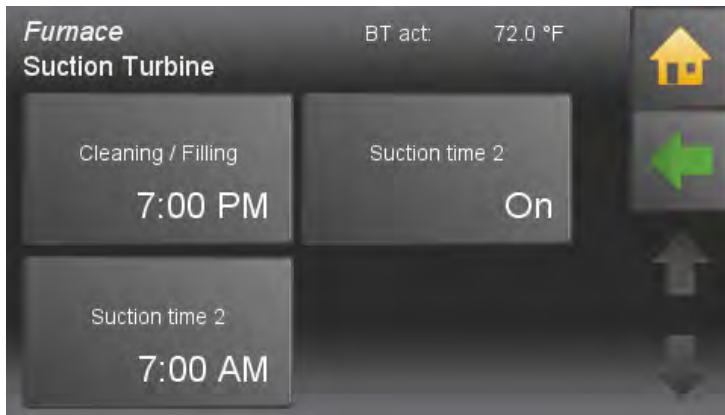

Set a Time (full hours), at which the hopper gets refilled, regardless how full it is at this time.
At this time, the fire tubes are also cleaned. This time matches the time set in the Cleaning/Filling menu and can be set at either menu.

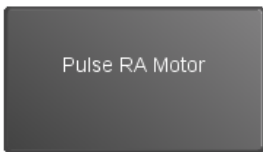

Frequency for storage room suction systems in pulse mode, only for vacuum systems.

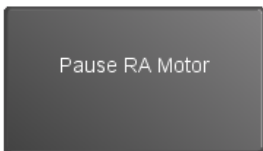

Pause time for storage room extractor motor - suction system in pulse mode. If pause time = 0 then no pulse mode.

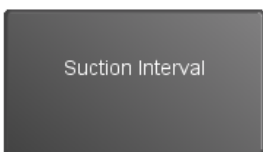

Run time of burner auger until next Suction Interval.
The hopper is filled at this time regardless whether it is empty or not.

- 175 min = 12 - 20 kW
- 225 min = 25 - 32 kW
- 90 min = 36 - 56 kW

16 General

General includes the complete heating control related settings and individual operating options for the customer.



General is in the Main menu.

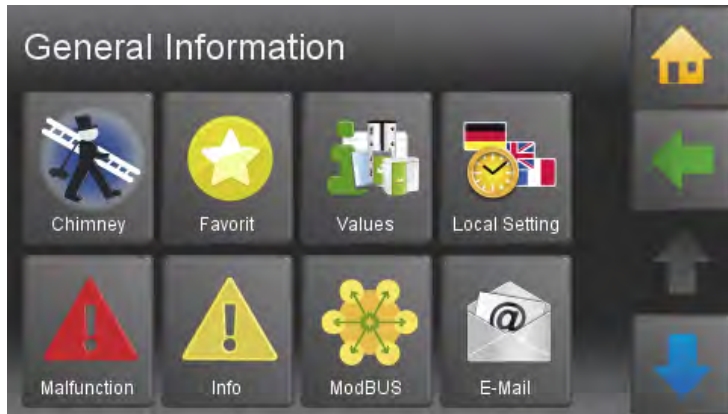

The menu **General** includes:

- Chimney
- Favorit
- Values
- Local setting
- Malfunction
- Info
- ModBUS
- E-Mail
- IP Config

16.1 Chimney

The function chimney is only for chimney draughts and authorized service technicians. It is used for the measurement of exhaust gas.



The menu item **Chimney** is situated in the menu General.

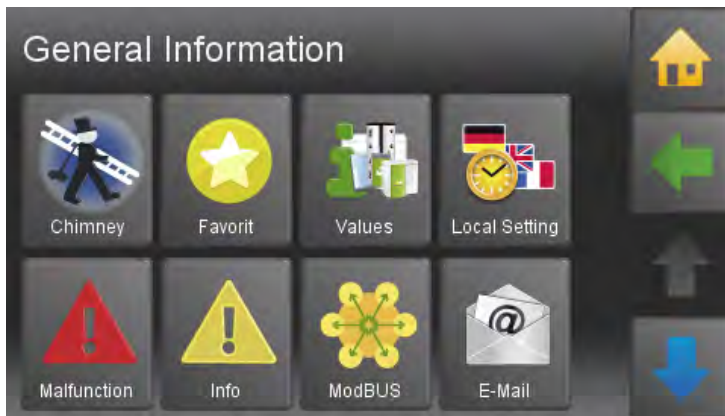

Please choose the function **Chimney**.



- The Furnace temperature is set to 140 °F for a total runtime of 30 minutes.
- You also can see actual Furnace temperature and the rest of the time limit.
- After the expiry of the time limit the function chimney ends.time of expiry the operation Chimney sweeper ends.
- The button Cancel ends the function Chimney.

16.2 Favorite



Favorite is in the menu General.

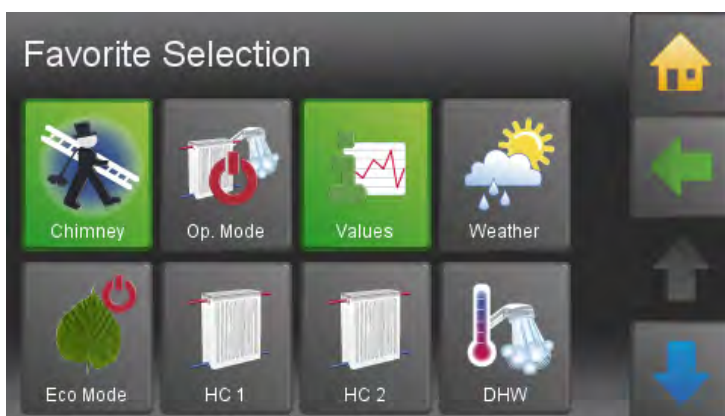

With this function you can display most commonly used menus in the start menu. This enables you a direct access. Select the menu item that should be displayed as a favorite 1 in the Start menu.

The selected item is green and the icon is displayed in the Start menu and is active.

16.3 Local Settings



Local Settings is in the menu General.



Local Settings has following menu items:

- Language
- Unit
- Date
- Time

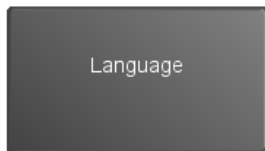

Choose between the languages German, English UK, English U.S. French, Spanish, Italian, Dutch, Danish and Russian.

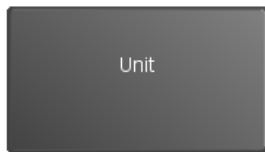

You can choose between isometric and imperialist number system.

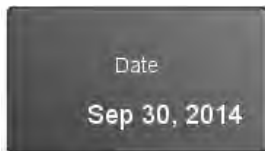

Set the current date.

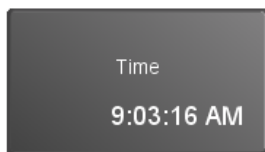

Set the current time.

16.4 Malfunction



Malfunction is in the menu General.

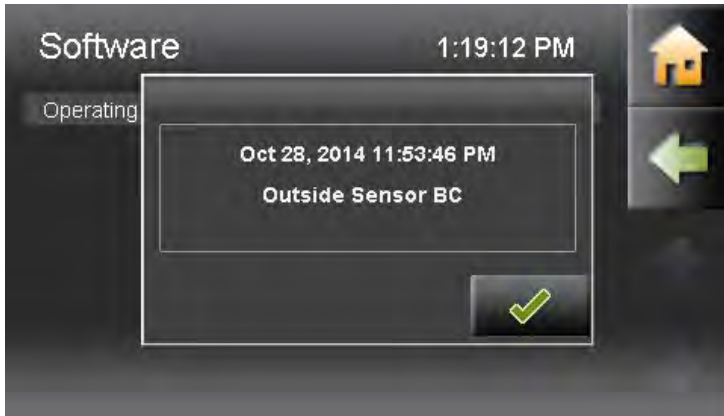

Fault messages can be overlaid on all menu items and appear immediately if a fault occurs. Every fault message appears with the date, time and name on the display. It remains until it is acknowledged.

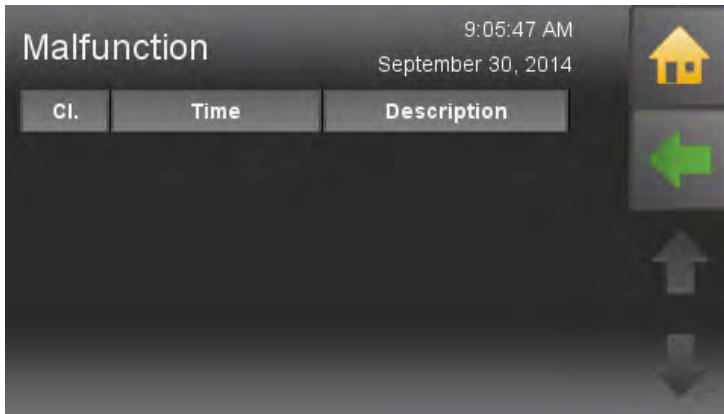

The menu remains the fault incident reports, as long as they are corrected up.

16.5 Information



Information is in the menu General.



In the menu item information are all faults listed chronologically.

The fault texts have 3 status

- C.....COME — when the fault occurs
- Q.....QUIT — when the fault has been rectified
- G.....GONE — when the fault has been reset by pressing ENTER

16.6 ModBUS

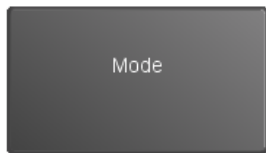

Off
TCP Server

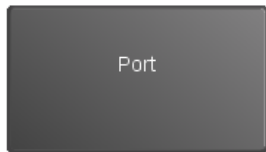

Defaultport for ModBUS is 502.

16.7 E-Mail

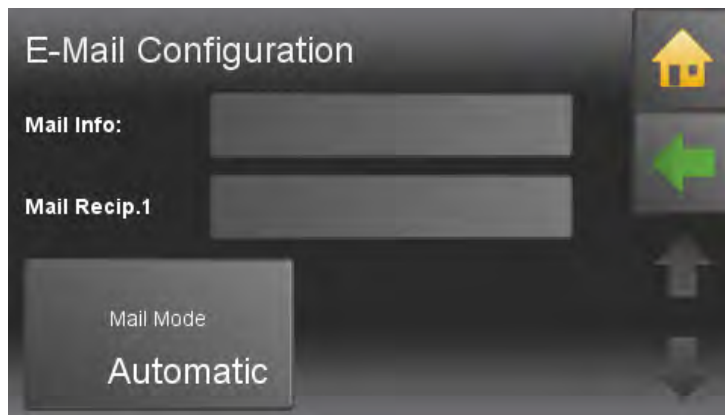

Delivery of disturbance-emails is done through an Maine Energy system server.

Only the recipient address needs to be configured.

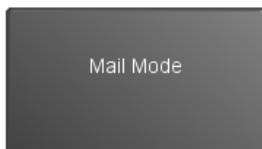

Mail Mode

To ensure maximal flexibility, E-mail settings can set individually.

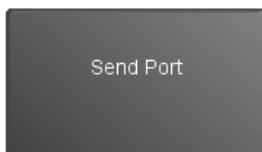

Send Port



Security

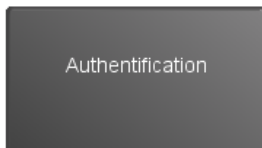

Authentication

16.8 IP Config

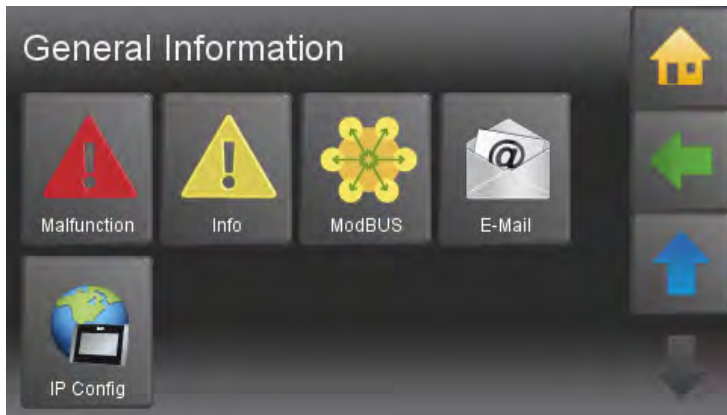

Please choose the submenu item **IP Config** in the menu General.

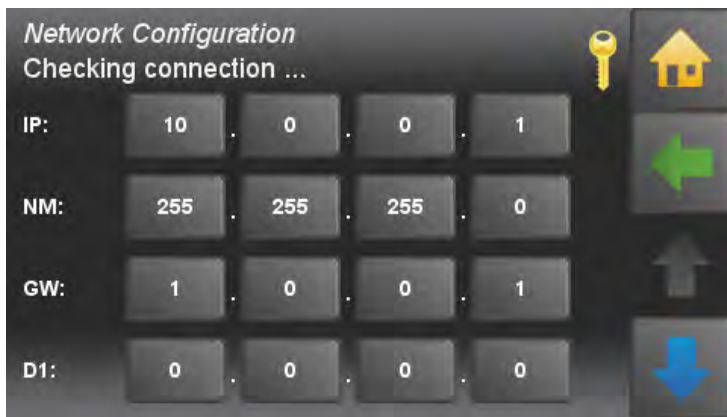

Insert the **IP (Address)**, **NM (Netmask)** and **GW (Gateway)**, D1 (in most cases similar to GW) and **D2 (optional)**.

IP: IP address in the local network

NM: Networkmask is required in the local network.

GW: The gateway enables the touch operating device the access to the internet.

D1, D2: Server, which provide routing information



Set **DHCP On** or **Off** depending on your network.

Enter the **Port** (Default **80**).

Web: IP address in local network

Web User: Networkmask is required in local network

Web Password: The gateway enables the touch operating device the access to the internet.

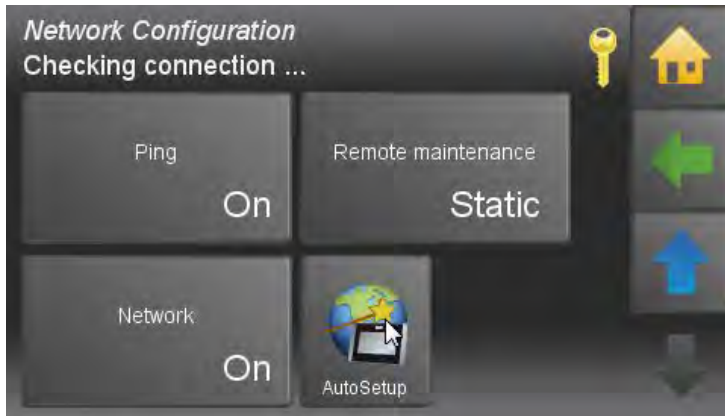

Activate optionally the **Ping** function.

NOTICE

To prevent the modem from switching into standby mode, a ping command is executed every 10 minutes.

You get the data from your network technician.

Configuration

This menu item is only active when a compatible USB wireless adapter is connected. (not every wireless stick works with the Touch operating device)
By default, this item is hidden and located in LAN mode.
If the wireless mode is enabled, a password box appears.

DHCP

Dynamic address assignment on the local network (should be disabled if possible).

WiFi

If a WLAN stick is recognized and supported, an Additional LAN & WLAN button appears.

Password

Password of router.

Port
0

Address extension with which the touch remote control is accessible.
In principle, you can make your own choice, certain ports are associated with special services, e.g. 25 Mail, 80 Web and so on.

Ping

The ping prevents the internet connection from being closed by the router. Therefore a query to the Maine Energy Systems server is started at certain time intervals.
So the router detects that the connection is still active.

Remote maintenance

Automatic This will attempt to automatically set up the router using the UPNP protocol port forwarding.
If this service is disabled on the router or doesn't work properly, it is canceled accompanied by an appropriate error message.
As this function is time-consuming (may take a few minutes), it is running in the background. Whatever the UPNP
If available, the Touch operating device registers on the Maine Energy Systems remote control server with its current external IP Address.
In case of change of address by the external provider, this is detected and sent to the server Maine Energy Systems.

Manual In this mode, the port forwarding must be set manually. (for lack of UPNP)

The port of the touch panel must correspond to the external shared port.

The touch then registers with the external IP address and port on Ök-oFEN remote maintenance server.

In case of change of address by the external provider, this is detected and sent to the Maine Energy Systems server.

Static

In this mode, no connection data is transferred to the Maine Energy Systems server and the online service of Maine Energy Systems can not be used.

But the remote controll of the Touch operating device remains active and can be uses as before via port forwarding, DynDns, fixed external IP, LAN and so on.

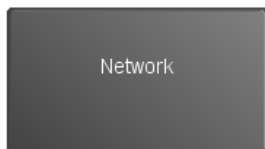

All functions for the network/internet can be disabled here.

Remote maintenance access



This function determines the network settings automatically.

For this the DHCP mode is activated and the required settings are set automatically.

Afterwards DHCP is deactivated.

Because of this, the IP address of the control unit can change.

The settings are set as follows:

- DHCP Off
- Ping On
- Port 8080
- Remote maintenance: Automatic



Back to the menu **General**.

17 Software



Software is in the Main menu.

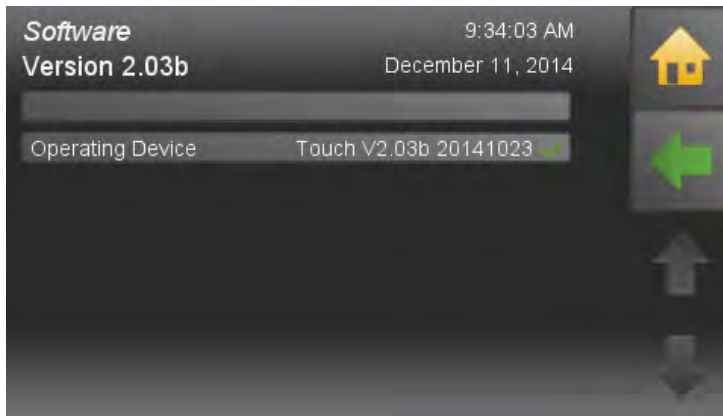

Software shows you the name of the current software.

18 Maintenance and servicing

Regular checks of the pellet heating system are a prerequisite for reliable, efficient and environment-friendly operation.

NOTICE

This wood heating appliance needs periodic inspection and repair for proper operation. It is against federal law to operate this wood heating appliance in a manner inconsistent with operating instructions in the manual.

18.1 Cleaning the Furnace every year

NOTICE

The pellet Furnace is equipped with an automatic cleaning system that cleans the heat exchanger every day. In addition, you need to clean the Furnace manually once a year before the start of the heating season.

NOTICE

Cleaning of the pellet Furnace has to be performed from a authorized service technician at least every third year.



WARNING

Risk of burns

Do not clean the Furnace until it has been allowed to cool down.
Switch off the heating system at least 6 hours before opening the Furnace.
Switch off the main switch before starting any maintenance work on the system.



CAUTION

Risk of cut injuries due to sharp edges
Use gloves.



CAUTION

INSPECT FLUE PIPES, FLUE PIPE JOINTS, AND FLUE PIPE SEALS REGULARLY TO ENSURE THAT SMOKE AND FLUE GASSES ARE NOT DRAWN INTO, AND CIRCULATED BY, THE AIR CIRCULATION SYSTEM



CAUTION

CLEANOUT OF THE HEAT EXCHANGER, FLUE PIPE, CHIMNEY, AND DRAFT INDUCER, IF USED, IS ESPECIALLY IMPORTANT AT THE END OF THE HEATING SEASON TO MINIMIZE CORROSION DURING THE SUMMER MONTHS, CAUSED BY ACCUMULATED ASH

Note:

Check first of all, if all seals are in a good condition and the doors closes tightly.

Procedure for cleaning the Furnace

You need:
 a) Brush
 b) Poker
 c) Vacuum cleaner with ash filter

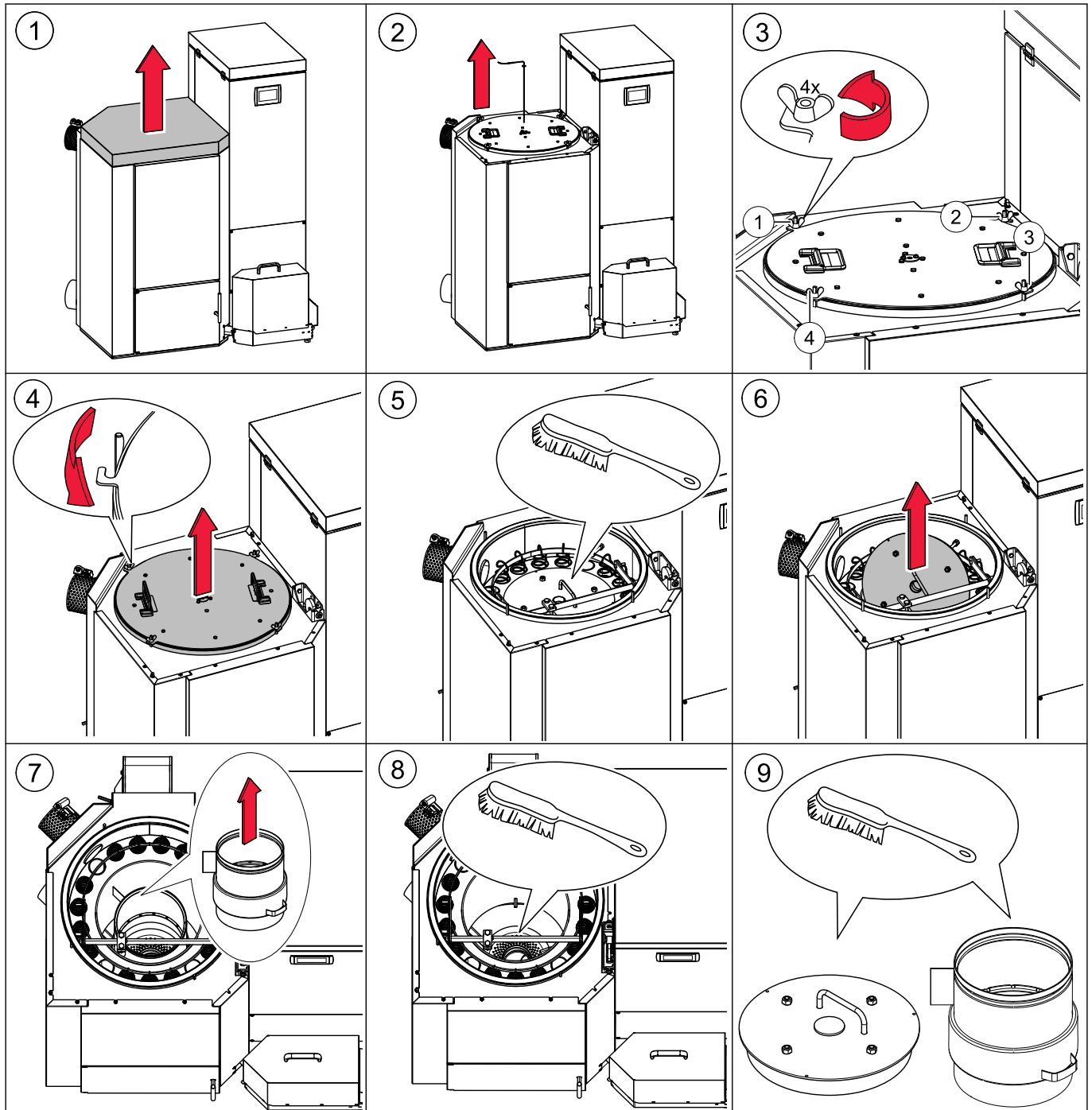
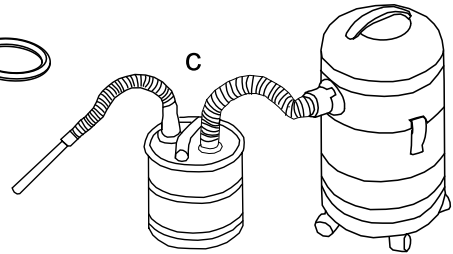
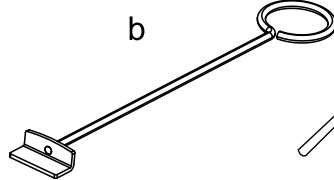
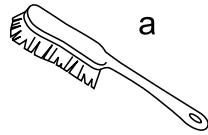

NOTICE

Reduction in Furnace performance and damage to pellet Furnace due to blockages in the air inlet
Clean the air intakes, the burner plate and the flame tube.

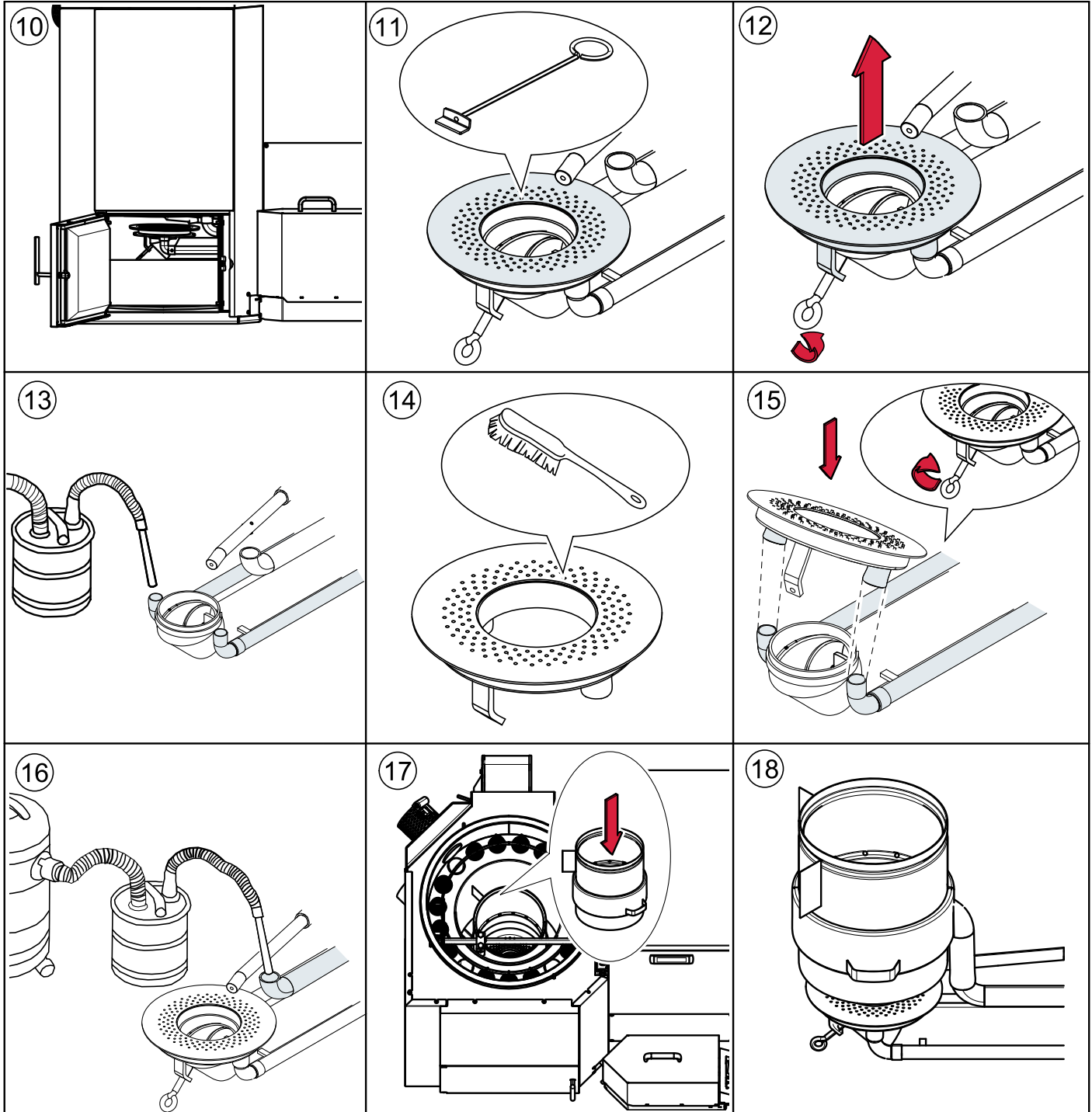

Note:

The individual parts of the multi segmented brazier may not be in raised position!

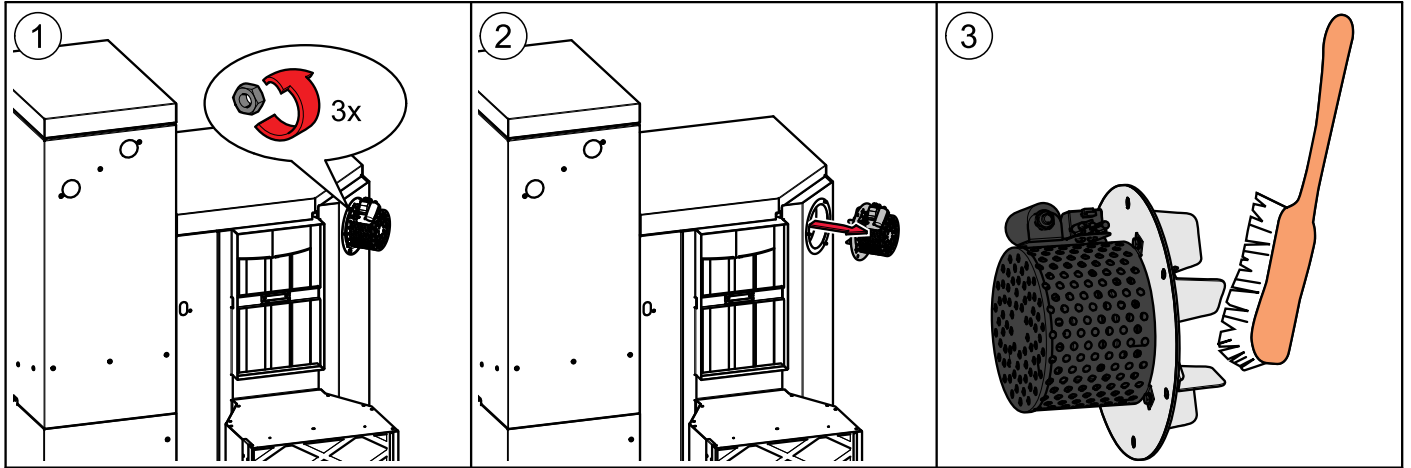
Cleaning the Induced draft blower:**18.2 Maintenance intervals**

We recommend taking out a maintenance contract with your service technician.

18.3 Repairs

Only authorised specialists may carry out repair work on this system. Use original spare parts only. Not using original spare parts will cause the warranty to become void.

18.4 Checking the Furnace room and storage room

Checking the pellet heating system regularly prevents malfunctions and unexpected failure of the heating system.

Furnace room

Make sure that no flammable materials are stored in the Furnace room.

Make sure that no washing is hanging in the Furnace room.

Check the display on the control panel for malfunction messages.

Check the flue gas tube and chimney. Clean it regularly.

Maintenance clearances as given in Installation Manual must be observed at all times.

Do not store fuel or any other materials within these clearances.

Storage room**DANGER****Risk of suffocation**

Ventilate the pellet storage room sufficiently before entering.
Switch off the heating system before entering.

Check the level of pellets in the textile tank and order more pellets in good time.

RESIDENTIAL LIMITED WARRANTY

What this Warranty Covers & Who it Applies to: The limited warranty provided by **Maine Energy Systems LLC** (“MESys”) applies only to MESys brand boilers, furnaces, wood pellet burners and accessories (“Product”) sold to you, the first user and purchaser provided that the Product was purchased: (1) for your normal, household (non-commercial) use, and has only been used for normal household purposes; (2) new at retail (not a display, “as is”, or previously returned model) and not for resale, or commercial use; and (3) within the United States. Products installed in a building other than a one or two family residential dwelling are not covered, under this Warranty unless individual Boilers are installed for each dwelling unit. Please return your registration card; while not necessary to establish warranty coverage, it allows MESys to be able to notify you in the unlikely event of a safety issue.

How Long this Limited Warranty Lasts: This Limited Warranty has three time frames, depending on the particular Product component involved.

(1) MESys warrants that the burner, ignition, electric and electronic parts, flame tube and burner plate, chains, bearings, chain pinions, and all other moving components of the Product are free from defects in materials and workmanship for a period of *two (2) years from the date of initial operation or 6,000 operating hours, whichever comes first*, provided they are installed and properly maintained by a qualified heating contractor and the other conditions of this warranty are met, and

(2) *In addition*, all other parts including the boiler vessel, or heat exchanger in furnaces, are warranted to be free from defects in materials and workmanship for a period of *five (5) years from the date of initial operation or 15,000 operating hours, whichever comes first* provided it is installed and properly maintained by a qualified heating contractor and the other conditions of this warranty are met; and

(3) *In addition* thereafter, MESys warrants that the boiler vessel is free from defects in materials and workmanship on a prorated basis follows, provided it is installed and properly maintained by a qualified heating contractor and the other conditions of this warranty are met:

For the next five (5) years (years 6 through 10) or a maximum of 30,000 operating hours, whichever comes first, the boiler vessel is warranted for 75% of the then retail parts cost; and thereafter

For the next ten (10) years (years 11 through 20) or a maximum of 60,000 operating hours, whichever comes first, the boiler vessel is warranted for 50% of the then retail parts cost.

For the next ten (10) years (years 21 through 30) or a maximum of 90,000 operating hours, whichever comes first, the boiler vessel is warranted for 25% of the then retail parts cost, which may be used to replace the boiler vessel, or used as a credit toward a new boiler system, at MESys’ discretion.

Labor is not covered under this limited warranty. During the pro-rated warranty period, the customer is responsible for payment of the remaining portion of the then retail cost.

The warranty period begins to run upon the date of initial operation, and shall not be extended for any reason whatsoever. This limited warranty does not cover labor and shipping costs, non-MESYS components, serviceable items or normal maintenance, nor the other items and events excluded below.

Terms of Limited Warranty: MESys will provide replacement parts for any component that proves to be defective in materials or workmanship (excludes labor charges) within the periods set forth above, or replace it with the most comparable model available from MESys at the time of the replacement, provided that the purchaser pays for the other portion of the prorated charge set forth above if applicable. The proportionate charge is based on the current list price of the boiler vessel involved in the warranty claim (or the nearest comparable MESys model). The foregoing timelines begin to run upon the date of initial operation, and shall not be stalled, tolled, extended, or suspended, for any reason whatsoever.

Repair/Replace as Your Exclusive Remedy: During this limited warranty period, MESys or one of its authorized service providers will provide replacement parts for your Product or replace it with the most comparable model then available from MESys at the time of the replacement (subject to certain limitations stated herein,) if your Product proves to have been manufactured with a defect in materials or workmanship. All removed parts and components shall become the property of MESys at its sole option. All replaced and/or repaired parts shall assume the status of the original part for purposes of this

warranty and this warranty shall not be extended by the replacement of such parts. MESys's sole obligation hereunder is to provide replacements for defective Product to a MESys-authorized service provider during normal business hours. For safety and property damage concerns, MESys highly recommends that you do not attempt to repair the Product yourself, or use an un-authorized servicer; MESys will have no responsibility or liability for repairs or work performed by a non-authorized servicer. If you choose to have someone other than an authorized service provider work on your Product, THIS WARRANTY WILL AUTOMATICALLY BECOME NULL AND VOID. Authorized service providers are those persons or companies that have been specially trained for customer service and technical ability (note that they are independent entities and are *not* agents, partners, affiliates or representatives of MESys).

Warranty Exclusions: The warranty coverage described herein excludes all defects or damage that are not the direct fault of MESys, including without limitation, any one or more of the following: (a) use of the Product in anything other than its normal, customary and intended manner (including without limitation, any form of commercial use or use that is not for personal, family or household purposes); (b) any party's willful misconduct, negligence, misuse, abuse, accidents, improper operation, failure to maintain, improper or negligent installation, tampering, failure to follow operating instructions, mishandling, unauthorized service (including self-performed "fixing" or exploration of the appliance's internal workings); (c) adjustment, alteration or modification of any kind; (d) a failure to comply with applicable state, local, city, or county electrical, plumbing and/or building codes, regulations and laws, including failure to install the product in strict conformity with local fire and building codes and regulations; (e) ordinary wear and tear; (f) any external, elemental and/or environmental forces and factors, including without limitation, lightning strikes, voltage spikes, flues that do not meet specified standards, fire, floods, rain, windstorm, floods, fires, mud slides, freezing, excessive moisture or extended exposure to humidity, power surges, building structural failures and acts of God; (g) any damage or failure resulting from contaminated air, including but not limited to sheetrock particles or other dirt or dust, introduced into the Boiler; (h) damage or failure resulting from hard water scale build-up on the heat exchanger waterways; (i) use with insufficient water or operation with water or fuel additives that cause deposits or corrosion; and (j) use with oxygen permeable tubing or other components. In no event shall MESys have any liability or responsibility whatsoever for damage to surrounding property and other structures or objects around the Product. Also excluded from this warranty are scratches, nicks, minor dents, and cosmetic damages on external surfaces and exposed parts; Products on which the serial numbers have been altered, defaced, or removed; service visits to teach you how to use the Product, or visits where there is nothing wrong with the Product; correction of installation problems (you are solely responsible for any structure and setting for the Product, including all chimneys, flues, electrical, plumbing or other connecting facilities, for proper foundation/flooring, and for any alterations); and resetting of breakers or fuses.

TO THE EXTENT ALLOWED BY LAW, THIS WARRANTY SETS OUT YOUR EXCLUSIVE REMEDIES WITH RESPECT TO PRODUCT, WHETHER THE CLAIM ARISES IN CONTRACT OR TORT (INCLUDING STRICT LIABILITY, OR NEGLIGENCE) OR OTHERWISE. THIS WARRANTY IS IN LIEU OF ALL OTHER WARRANTIES, WHETHER EXPRESS OR IMPLIED. ANY WARRANTY IMPLIED BY LAW, WHETHER FOR MERCHANTABILITY OR FITNESS FOR A PARTICULAR PURPOSE, OR OTHERWISE, SHALL BE EFFECTIVE ONLY FOR THE PERIOD THAT THIS EXPRESS LIMITED WARRANTY IS EFFECTIVE OR THE IMPLIED WARRANTY PERIOD, WHICHEVER IS LESS. IN NO EVENT WILL MESYS BE LIABLE FOR CONSEQUENTIAL, SPECIAL, INCIDENTAL, INDIRECT, "BUSINESS LOSS", AND/OR PUNITIVE DAMAGES, LOSSES, OR EXPENSES, INCLUDING WITHOUT LIMITATION TIME AWAY FROM WORK, HOTELS AND/OR RESTAURANT MEALS, EXPENSES IN EXCESS OF DIRECT DAMAGES DEFINITELY CAUSED EXCLUSIVELY BY MESYS, OR OTHERWISE ARISING. SOME STATES DO NOT ALLOW THE EXCLUSION OR LIMITATION OF INCIDENTAL OR CONSEQUENTIAL DAMAGES, AND SOME STATES DO NOT ALLOW LIMITATIONS ON HOW LONG AN IMPLIED WARRANTY LASTS, SO THE ABOVE LIMITATIONS MAY NOT APPLY TO YOU. THIS WARRANTY GIVES YOU SPECIFIC LEGAL RIGHTS, AND YOU MAY ALSO HAVE OTHER RIGHTS, WHICH VARY FROM STATE TO STATE.

The customer is responsible for the costs of:

- Components which have been replaced but found not to have been defective;
- Faulty installation;
- Normal maintenance; and
- Equipment used contrary to the installation manual.

The required information that must be furnished to MESYS for a claim under this Limited Warranty includes:

- Model number and serial number of the Product;
- Date the Product was installed and placed in operation, the location, the name of the installer;
- Date the Product component failure was reported; and

- Description of condition that prompted the report.

No attempt to alter, modify or amend this warranty shall be effective unless authorized in writing by an officer of MESYS.

To Obtain Warranty Service, Please Contact

Maine Energy Systems, LLC ("MESys")

8 Airport Road, P.O. Box 547, Bethel, Maine 04217

Tel: 207.824. 6749 Fax: 207.824.4816

info@maineenergysystems.com

Limited Warranty Boiler Resid 1-31-2013 REV
6/13/2013 3:46 PM

General Information

As required by the United States Environmental Protection Agency the following information is given for the: AutoPellet Air 28 wood pellet fired central heating Warm Air Furnace. Manufactured by Maine Energy Systems, of 8 Airport Road, Bethel, Maine, 04217

- The AutoPellet Air 28 has a thermal output levels from 4 kW or 17,000 btu/h to 95,000 btu/h and complies with EPA 2020 requirements.
- This wood heater has a manufacturer-set minimum low burn rate that must not be altered. It is against federal regulations to alter this setting or otherwise operate this wood heater in a manner inconsistent with operating instructions in this manual.
- Complete installation information is found in the Installation Manual.
- Although operational information is elsewhere in this manual, there are specific concerns for correct operation that can directly affect the emissions profile of this equipment. It is therefore necessary that we mention these important points.
- Fuel loading and selection. Your AutoPellet Air 28 is equipped with completely automatic fuel loading. Thus, other than selecting the correct fuel, there are no loading instructions as such. Fuel selection is straight forward.

Only PFI Premium 100% wood pellets should be used in your boiler.

- Among the materials that are specifically prohibited to be burned in your AutoPellet Air 28 are: trash, plastics, gasoline, rubber, naphtha, household garbage, material treated with petroleum products such as particleboard, railroad ties, and pressure treated wood.

Burning these materials may result in release of toxic fumes or render the boiler ineffective and cause smoke.

- Your AutoPellet Air 28 is completely automatic ignition as well as the loading as before mentioned.

There are therefore no starting procedures to be followed. The boiler correctly starts itself when required by building load.

- There are no user adjustments required for the air controls on your AutoPellet Air 28.
- It is important to have your AutoPellet Air 28 serviced by a trained professional who is aware of the importance to ensure that there are no inlet air restrictions in or around your boiler's combustion blower. And that the air passages within your boiler are free of debris, (creosote, ash, etc.) The flue pipe and chimney are also clean and free of debris / restrictions. And that the combustion chamber door seal is airtight when the door is closed and secured.
- Ash removal is also completely automatic on your AutoPellet Air 28. Ashes should be placed in a metal container with a tight-fitting lid.

The closed container of ashes should be placed on a noncombustible floor or on the ground, away from all combustible materials, pending final disposal. The ashes should be retained in the closed container until all cinders have thoroughly cooled.

When cooled ashes can be disposed of on your lawn, garden or local transfer station.

Your AutoPellet Air 28 is not a catalytic type burner.

- A person or persons responsible for the operation of a warm air furnace must comply with all applicable laws or other requirements, such as State laws or regulations as well as local ordinances.
- A person or persons operating a warm air furnace should be aware that they are responsible for operation in such a manner that does not create a public or private nuisance condition. The Manufacturer's distance and stack height recommendations and the requirements in any applicable laws or other requirements may not always be adequate to prevent nuisance conditions due to terrain or other factors.
- Your AutoPellet Air 28 should be installed with a minimum stack height of 16 feet. Providing correct draft as given in the Installation manual.
- Draft is the force which moves air from the appliance up through the chimney. The amount of draft in your chimney depends on the length of the chimney, local geography, nearby obstructions and other factors. Too much draft may cause excessive temperatures in the appliance and may damage the catalytic combustor. Inadequate draft may cause backpuffing into the room and 'plugging' of the chimney. Inadequate draft will cause the appliance to leak smoke into the room through appliance and chimney connector joints and an uncontrollable burn or excessive temperature indicates excessive draft.
- The efficiency of your AutoPellet Air 28 running at full power is >86%.
- This is the result of a laboratory test and was measured using the HHV of the fuel used.
- You should never operate a combustion appliance of any type in your home without there being a properly installed smoke and CO detector.

Your local fire department usually has good advice on placement of these detectors and how many your home may need for complete coverage.



MESys
 Maine Energy Systems, LLC
 8 Airport Road, Bethel, Maine 04217
 Voice: 207.824.6749 Fax: 207.824.4816

Report No. 0444PH005S

Type: AutoPellet Air 28		S/N: XUF00100	CATALOG No.: PFS28
Date of manuf.: 07/2015		Rated heat power: 95540 BTU/hr	
Tested to: UL 391-2010. CSA B366.1-2011			
Manufactured By: MESys LLC, Bethel, Maine		FUEL: Wood Pellets	
U.S. ENVIRONMENTAL PROTECTION AGENCY certified to comply with the 2020 particulate emissions standard using wood pellets.			
This appliance needs periodic inspection and repair for proper operation. Consult owner's manual for further information. It is against federal regulations to operate this appliance in a manner inconsistent with operating instructions in the owners manual.			
Particulate Emissions, 0.06 lb./million btu - 1.32 grams/hr. CO Emissions, 0.029 grams/min. Annual Efficiency, (HHV) 88.35%			
FUEL: PREMIUM WOOD PELLETS		Max Operating Temp: 194 °F	
Furnace tested to .2 inches WC external static pressure			
Chimney	Approved factory built stainless steel or tile-lined masonry		
MAX DRAFT: 0.11 inches WC MIN DRAFT: 0.04 inches WC			
Diameter: 6 INCH		Electrical Rating: 220 V, 60 Hz, 12 A, 2300 W	
FLOORING: COMBUSTIBLE FLOORS CAN BE USED WITH A NON-COMBUSTIBLE SHIELD. MINIMUM CLEARANCES ARE 18IN/457MM IN THE FRONT AND 8IN / 203MM ON EACH SIDE.			
PARTS	Fan Flue Gas: E1001A	Controller Display: E1330	
Motor Ash Box: E1302		Motor Flame Return Protection: E1413A	
Motor Cleaning Device: E1054		Motor Hopper: -----	
Motor Burner Plate Cleaning: -----		Suction Turbine: E1192	
Motor Burner Screw: E1002			
Controller Board: E1412			
Fan Burner: E1005S			

Author & Manufacturer

MAINE ENERGY SYSTEMS LLC
8 Airport Road – P.O. Box 547 Bethel
Maine 04217

E-Mail: info@maineenergysystems.com
www.maineenergysystems.com

© MAINE ENERGY SYSTEMS LLC
Subject to modifications